

MONTECITO FIRE PROTECTION DISTRICT
AGENDA FOR THE REGULAR MEETING
OF THE BOARD OF DIRECTORS

Montecito Fire Protection District Headquarters
595 San Ysidro Road
Santa Barbara, California

March 24, 2014 at 2:00 p.m.

Agenda Items May Be Taken Out Of The Order Shown

1. Public comment: Any person may address the Board at this time on any non-agenda matter that is within the subject matter jurisdiction of the Montecito Fire Protection District. (30 minutes total time is allotted for this discussion.)
2. Second Reading of Ordinance No. 2014-01 adopting the Fire Protection Plan for the Montecito Fire Protection District and repealing Ordinance No. 2010-02.
3. Report from the Finance Committee (copy of Agenda for Finance Committee Meeting attached).
 - a. Consider recommendation to approve District's warrants and claims.
4. Approval of Minutes of February 18, 2014 Regular Meeting
5. Approval of Minutes of February 25, 2014 Special Meeting.
6. Fire Chief's report.
7. Board of Director's report.
8. Suggestions from Directors for items other than regular agenda items to be included for the April 28, 2014 Regular Board meeting.

Adjournment

This agenda is posted pursuant to the provisions of the Government Code commencing at Section 54950. The date of the posting is March 19, 2014.

MONTECITO FIRE PROTECTION DISTRICT

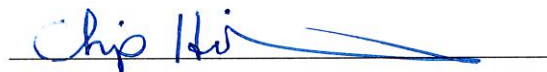

Chip Hickman, Fire Chief

Agenda

Item #2

ORDINANCE NO. 2014-1**AN ORDINANCE OF THE GOVERNING BOARD OF THE MONTECITO FIRE PROTECTION DISTRICT ADOPTING THE FIRE PROTECTION PLAN FOR THE MONTECITO FIRE PROTECTION DISTRICT AND REPEALING DISTRICT ORDINANCE NO. 2010-2.**

WHEREAS, the Montecito Fire Protection District operates under the provisions of California's Fire Protection District Law of 1987, wherein the State Legislature declared that the local provision of fire protection services, rescue services, emergency medical services, hazardous material emergency response services and other services relating to the protection of lives and property is critical to the public peace, health and safety of the State of California and that local control over the types, levels and availability of these services is a long-standing tradition in California; and

WHEREAS, the State Legislature has also declared that its intent is to provide broad statutory authority for local fire protection districts, encouraging local officials to adopt powers and procedures set forth in the Fire Protection District Law of 1987 to meet their own circumstances and responsibilities; and

WHEREAS, Health and Safety Code Section 13861 provides the District with certain powers, including the power to establish and enforce rules and regulations.

NOW THEREFORE, the Governing Board of the MONTECITO FIRE PROTECTION DISTRICT ordains as follows:

Section 1. Repeal of Previous Fire Protection Plan.

Ordinance No. 2010-2 of the Montecito Fire Protection District is hereby repealed.

Section 2. Adoption of Fire Protection Plan.

There is hereby adopted by the Board of Directors ("Board") of Montecito Fire Protection District ("District") the Montecito Fire Protection Plan ("Plan")

attached hereto as Exhibit A and incorporated in full herein by this reference.

The Plan contains the following sections:

1. Section 1 – Roofing Assembly Requirements.
2. Section 2 – Vegetation Management. (Including Figure 2-1)
3. Section 3 – Access Requirements for Roads and Driveways (Including Figures 3-1, 3-2, 3-3 and 3-4).
4. Section 4a – Water Supply for Fire Protection (Including Figures 4a-1 and 4a-2).
5. Section 4b – Water Storage for Fire Protection (Including Figure 4b-1).
6. Section 5a – Installation Requirements for Residential Sprinkler Systems.
7. Section 5b – Installation Requirements for Non-Residential Sprinkler Systems.
8. Section 6 – Request for Modifications for Post Disaster Rebuilds.

The purpose of the Plan is to establish regulations governing conditions dangerous to life and property from fire. Further, the Plan is intended to supplement the District’s adoption of the current version of the California Fire Code, including amendments to the California Fire Code, Building Code and Residential Code (collectively “Code”). In the event of any conflict between the requirements of the Plan and the requirements of the Code, the more restrictive requirement shall govern.

Section 3. Enforcement and Penalties.

(a) Any person who violates any of the provisions of this Ordinance or fails to comply therewith, or who violates or fails to comply with any order made hereunder shall severally for each and every such violation and non-compliance, respectively, be guilty of an infraction punishable by a fine of not more than

\$250. The imposition of one penalty for any violation shall not excuse the violation or permit it to continue; and all such persons shall be required to correct or remedy such violations or defects within a reasonable time; and when not otherwise specified, each ten days that prohibited conditions are maintained shall constitute a separate offense.

(b) The application of the above penalties shall not be held to prevent the enforced removal of prohibited conditions. If a violation is determined to exist or to be impending, the Fire Chief is authorized to take such measures as are deemed necessary or expedient to secure compliance. In carrying out such measures, the Fire Chief and his agents may request, and shall receive, the assistance and cooperation of the County Building Official or other appropriate officials of the County of Santa Barbara.

(c) When the Fire Chief determines that any person has engaged in, is engaged in, or is about to engage in any act(s) or practice(s) which constitute or will constitute a violation of any provision of this Ordinance or the Plan hereby adopted, the District Attorney or District Counsel may make application to the Superior Court of Santa Barbara County for an order restraining or enjoining such act(s) or practice(s), a permanent or temporary injunction, restraining order or other corrective order may be granted.

(d) In the event that any person, firm or corporation, whether as a principal, agent, employee or other type of representative shall fail to abate or correct a violation of any provision of this Ordinance or the Plan hereby adopted after notice and opportunity to correct or end same, the District Attorney or District Counsel may apply to the Superior Court of the County for an order authorizing the District to undertake actions necessary to abate the violation and to require the violator to pay for the cost of such undertaking.

(e) Any person, whether as principal, agent, employee or other type of representative who maintains any premises in violation of any provision of this

Ordinance or the Plan hereby adopted shall be liable for and obligated to reimburse the District for all costs incurred by the District in obtaining compliance, or which are attributable to or associated with any enforcement action, whether such action is administrative, injunctive or legal; and for all damages suffered by the District, its agents, officers and employees as a result of such violation or efforts to enforce compliance.

(f) Any violation of any provision of this Ordinance or the Plan and any amendment thereto may, in the discretion of the District Attorney for the County of Santa Barbara, be prosecuted as a misdemeanor.

Section 4. Liability.

It is the intent of the Board to establish minimum standards for the protection of the public health, safety and welfare. This Ordinance shall not be construed to establish standards of performance, strength, or durability other than those specified. Neither this Ordinance nor any services rendered in connection with or pursuant to its terms by Fire District officers, agents or employees, are intended as nor shall be construed to be the basis for any express or implied warranties or guarantees to any person concerning any structure or portion thereof or appurtenance thereto constructed, repaired, replaced or removed pursuant to this Ordinance or the Plan hereby adopted.

Section 5. Findings.

The Board, following due consideration, hereby finds and determines that the adoption of the Plan is reasonably necessary due to local climatic, geological, and topographical conditions existing in the District. The District hereby finds and declares that:

The area within which the District is located regularly experiences strong, hot, dusty, and down canyon winds referred to locally as "Santa Anas" or "Sundowners."

Such wind conditions increase fire danger by significantly contributing to the spread and intensity of fires, and significantly increase the difficulty of effective fire suppression within the District.

If a fire involving a single structure cannot be immediately extinguished, such wind conditions can rapidly spread flames to adjacent structures, significantly endangering lives and/or millions of dollars in property value.

Such winds can spread existing flames from a structure or natural fuel to structures and natural fuel significant distances away, even jumping over fire breaks and freeways, resulting in significant property damage and/or loss of life.

Much of the jurisdiction of the District is within heavy brush and chaparral.

It is generally known to take about 25 years to build up extremely dangerous combustible brush conditions, and the District contains areas where combustible flora has built up for 50 to 100 years.

The District is in an area prone to extensive drought conditions, significantly increasing the already natural combustibility of the chaparral, brush and ornamental shrubbery in the District.

Such fuels can rapidly transform a small manageable fire into an uncontrollable conflagration, compromising the lives and safety of District personnel and residents.

The reduction of such fuels provides a direct correlation to the safety of the lives and property within the District, and will substantially reduce the risk of injury or death to District personnel.

The District is geographically situated such that extreme solar exposure (south, southwest, and west facing slopes) continually results in critically low live fuel moisture levels, further rendering most brush, chaparral and ornamental shrubbery highly combustible.

Due to these conditions even non-structural fires can pose a massive threat to the lives and structures located in the District.

The District is located in close proximity to several active earthquake faults.

During and after an earthquake, there is a high potential for fires and other emergencies threatening the lives of District residents, generally requiring the commitment of all available resources.

Geographic and topographic conditions delay response times for fire apparatus (these conditions include remote structures; narrow, winding roads which hamper the access of modern fire suppression apparatus; and extremely sloping roads which tend to slow fire apparatus response).

Water can be in short supply in the District, and fires in areas with structures with noncombustible roofing typically consume far lesser quantities of water than those not complying with the Ordinance, allowing greater fire suppression coverage, and preventing unnecessary loss of life and/or property within the District.

U.S. Highway 101 traverses the District, and is a transportation route for hazardous materials and some traffic accidents on Highway 101 require the presence of all available fire apparatus, leaving the District with fewer resources to combat structural fires elsewhere in the District.

The Union Pacific Railroad line also traverses the District, and a train accident or derailment could immediately deplete the District's resources, limiting the District's ability to furnish fire protection for the balance of the District.

The Montecito Fire Protection District is in the mutual aid plan and is committed to supply personnel and equipment for serious fires outside the District and which can reduce the personnel and equipment available for response to possible emergencies within the District.

Further, in many instances because of the extra hazardous conditions, a defensible space protection zone around buildings and structures of only one hundred feet is not sufficient to provide for tenable wildland firefighting operations around such buildings and structures. These conditions are common upon lands within the District that are located within the Montecito Resource Management Zone as designated by the County of Santa Barbara. Such areas are generally rural areas with slopes exceeding 40% and are covered

with old age class chaparral and dense vegetation, creating conditions that are dangerous to fire fighters. The Fire District has designated these areas as Very High Fire Hazard Severity Zones on the Montecito Fire Protection District's Fire Hazard Severity Zones Map.

Portions of the District, however, that are designated on the Montecito Fire Protection District's Fire Hazard Severity Zone Map as High Fire Hazard Severity Zone rather than Very High Fire Hazard Severity Zone as previously designated by the California Director of Forestry and Fire Protection are in residential areas located south of East Valley Road (Highway 192). This area is comprised of more gentle terrain, with less dense brush, and ornamental landscape vegetation around the residences and estates. Road access in this area is moderate. Due to these conditions as compared to the conditions in the Very High Fire Hazard Severity Zone, the District designated this area as High Fire Hazard Severity Zone.

The Governing Board expressly finds and declares that the findings contained herein provide the basis for the amendment, deletions, and additions to the Code contained in this Ordinance.

Section 7. Severability.

If any article, section, subsection, sentence, clause, phrase or word of this Ordinance is for any reason held to be unconstitutional or invalid, such holding shall not affect the validity of the remaining portions of this Ordinance. The Board hereby declares that it would have passed this Ordinance and each article, section, subsection, sentence, clause, phrase or word thereof irrespective of the fact that any one or more articles, sections, subsections, sentences, clauses, phrases or words may be unconstitutional or invalid.

Section 8. Effective Date and Publication.

(a) Effective Date. This Ordinance was introduced for first reading on January 21, 2014, and passed on February 18, 2014, and shall take effect 30 days after final passage.

(b) Publication. In accordance with Section 25124 of the Government Code, this Ordinance shall be published once, with the names of the members of the Board voting for and against it in a newspaper of general circulation in the District within fifteen (15) days after its adoption.

PASSED, APPROVED AND ADOPTED by the Governing Board of the MONTECITO FIRE PROTECTION DISTRICT on this 24th day of March, 2014, by the following vote:

AYES:

NAYS:

ABSTAIN:

ABSENT:

John Venable, President
MONTECITO FIRE PROTECTION DISTRICT

ATTEST:

John Abraham Powell, Secretary

STATE OF CALIFORNIA)
)
 COUNTY OF SANTA BARBARA) ss.

I, John Abraham Powell, Secretary of the Governing Board of the Montecito Fire Protection District, DO HEREBY CERTIFY that the above and foregoing is a full, true and correct copy of Ordinance No. 2014-1 of said District, adopted at a regular meeting of the Governing Board, held on the 24th day of March, 2014, at which meeting a quorum of the Governing Board was present and acting throughout, and that the same has not been amended or repealed.

DATED: This 24th day of March, 2014.

 John Abraham Powell, Secretary
 MONTECITO FIRE PROTECTION DISTRICT

EXHIBIT A

MONTECITO FIRE PROTECTION PLAN



MONTECITO FIRE PROTECTION DISTRICT

595 San Ysidro Rd □□ Santa Barbara, California 93108 □□ (805) 969-7762 □□ FAX (805) 969-3598

MONTECITO FIRE PROTECTION DISTRICT FIRE PROTECTION PLAN

Section 1

ROOFING ASSEMBLY REQUIREMENTS

The Montecito Fire Protection District has mandated that any new or replacement roofing assembly will meet the requirements of the current version of the Code as being “Class A – suitable for extreme fire exposure”. This requirement was based upon the horrendous experience throughout the region with combustible roofing during wildland interface fires.

This requirement exceeds that which the County of Santa Barbara Building & Safety Division (“County”) enforces in other “High Fire Hazard Areas” within unincorporated county areas. The County minimally requires a “Class B – suitable for moderate fire exposure” roofing assembly and further prohibits the use of wood roofing materials.

Replacement of existing and/or application of additional new roof material which amounts to more than 25% of the total roof area would require removal and replacement of the entire roof with conforming class A roofing material.

The Fire District is responsible for the reviewing plans and contract documents for all new and/or replacement roofing projects occurring within its jurisdiction. Roofing permits are initiated through the standard Fire Protection Certificate Application (FPC) process currently utilized for all building permits within unincorporated areas of the County. The County Building Official is responsible for the inspection of any roof installation within the Fire District.

The Fire District reviews plans and/or roofing contracts to verify that a conforming “Class A” roof is being proposed for installation. The contractor or owner’s agent is required to produce such documentation for review by Fire District personnel. Generally a cursory comparison between this documentation and the roofing manufacturer’s product specifications will confirm compliance with the plan review aspects of the Code.

A blank FPC form may be obtained either at the County Building & Safety Division or from the Fire District. The applicant will complete this application and submit it, along with copies of the contract documents, to the Fire District for review. The applicant may submit this documentation by facsimile. In completing the review, Fire District personnel will note the general description of the approved roofing assembly at the bottom of the FPC before signing and dating it.

To obtain the roofing permit, the project applicant would then deliver the FPC to the County Building & Safety Division at which time the County would issue its permit in due course.



MONTECITO FIRE PROTECTION DISTRICT

595 San Ysidro Rd ☐☐ Santa Barbara, California 93108 ☐☐ (805) 969-7762 ☐☐ FAX (805) 969-3598

Rooftop Gardens and Landscape Roofs:

The Fire District will allow rooftop gardens / landscaped roofs on a case by case basis but must have prior approval by the District Fire Official.

If approval is granted, only succulent vegetation will be permitted for rooftop gardens and landscape roofs and shall be installed and maintained in accordance with Section 317 of the California Fire Code and Sections 1505.0, 1507.16, and 705A of the California Building Code.



MONTECITO FIRE PROTECTION DISTRICT

95 San Ysidro Rd * Santa Barbara, California 93108 * (805) 969-7762 * FAX (805) 969-3598

MONTECITO FIRE PROTECTION DISTRICT FIRE PROTECTION PLAN

Section 2

Vegetation Management

The purpose of this section is to establish minimum standards for protection of life and property by reducing fuel loading and increasing the ability of a building located in any Fire Hazard Severity Zone within the District to resist the intrusion of flames or burning embers projected by a vegetation fire and contribute to a systematic reduction of conflagration losses through the use of performance and prescriptive requirements.

Code Standard References:

- California Resource Code Section 4291
- California Government Code Sections 51175 through 51189
- California Fire Code 2013 Edition Section Chapter 49
- California Building Code 2013 Edition Section 705A

I Hazard Abatement for Vacant Parcels

Annual grasses/ readily combustible fuels (less than ¼ inch shaft diameter). This standard applies to all parcels, regardless of proximity to structures.

1. Parcels less than one acre in size: All grasses shall be mowed or disked to less than 3 inches in height.
2. Parcels one acre or larger in size: Create 30 foot wide fuel breaks around and across the property dividing it into approximately one acre sections. Grasses shall be mowed or disked to less than 3 inches in height.
3. The use of mechanized equipment such as discs and plows, which tend to disturb soils, shall be avoided in all environmentally sensitive habitat areas.

II Fire Hazard Severity Zones in Montecito

Moderate Fire Severity Zone

- *The area of the Fire District south of Highway 101*

High Fire Severity Zone

- *The area of the Fire District north of Highway 101, east of lower Hotsprings and Sycamore Canyon roads, south of Hwy 192 and west of Sheffield Drive. Refer to Figure 2-1.*



MONTECITO FIRE PROTECTION DISTRICT

95 San Ysidro Rd * Santa Barbara, California 93108 * (805) 969-7762 * FAX (805) 969-3598

Very High Fire Severity Zone

- *The area of the Fire District east of the District boundary with Santa Barbara City from intersection with lower Hot Springs Road, west of Sycamore Canyon Road, north of Hwy 192, east of east of Sheffield Drive and west of District boundary with Carpinteria-Summerland Fire District. Refer to figure 2-1.*

III Vegetation Clearance from Structures

Defensible Space: The term defensible space refers to an area around a structure that is free from flammable vegetation and objects. Defensible space creates a zone around the structure that provides a key area of defense from an approaching wildfire while allowing firefighters to operate safely in protecting structures. Research results clearly demonstrate that defensible space improves the probability of house survival during wildfire.

1. Property Owners shall maintain defensible space of 100 feet from all sides of any structure but not beyond the property line except when adverse conditions exist as referenced in paragraphs 2 and 3 below.

The level to which the Fire District will require fuel modification will depend on the flammability of the structure pursuant to building materials used, building standards in place at the time, location, and type of surrounding vegetation.

Defensible space shall be maintained so a wildfire burning under average weather conditions would be unlikely to ignite the structure. Further, a working structure fire would be less likely to ignite adjacent vegetation if adequate defensible space is provided.

Specimen trees or other ornamental vegetation needs to be pruned and maintained so as to prevent transmission of fire to a structure.

The level to which fuels are required to be managed will vary within the 100-foot perimeter of the structure. The most aggressive clearing of vegetation occurs within the first 30 feet around the structure. Consistent with fuels management objectives, steps should be taken to minimize erosion. For the purposes of this section, “fuel”, means any combustible material including petroleum-based products and wildland vegetation.

- a. All mature trees shall be trimmed up off the ground 6 feet above grade level. For young/immature trees ensure limbs are trimmed well above ground level. The objective is to prevent a ground fire from spreading into the tree canopy.



MONTECITO FIRE PROTECTION DISTRICT

95 San Ysidro Rd * Santa Barbara, California 93108 * (805) 969-7762 * FAX (805) 969-3598

- b. All native brush and shrubs within the required 100 foot defensible space should be thinned and stripped of dead and/or decadent fuels.
 - c. Provide and maintain adequate spacing between the plants in order to minimize fire spread.
 - d. Remove that portion of a tree that extends to within 10 feet of the outlet to a chimney or stovepipe.
 - e. Maintain any tree, shrub, or other plant that is adjacent to or overhanging a building free of dead or dying wood.
 - f. Maintain the roof of a structure free of leaves, needles, or other vegetative materials.
 - g. If it is necessary or desirable to re-vegetate, refer to the plant list located on the Fire District website for guidelines.
“Creating Firewise Landscapes” *montecitofire.com*
2. A greater distance than that required under paragraph 1 may be required by special order from the Fire Chief or designee if additional distance is necessary due to extreme risks. Such risks could include, but not limited to, slopes greater than 40%, heavy decadent fuels, and there is no other feasible mitigation measure possible to reduce the risk of ignition or spread of wildfire to the structure.
 3. Clearance on adjacent properties may be required if it is determined that additional clearing is necessary to significantly reduce the risk of transmission of flame, heat, or embers sufficient to ignite the structure and there is no other feasible mitigation measure to reduce that risk. Additionally, the property owner must have done everything reasonable for good defensible space and fire hardened structure on their property. Clearance on adjacent properties shall only be conducted following written consent by the adjacent landowner. It is the responsibility of the property owner to obtain such consent, not the Fire District.
 4. The Fire Chief may authorize the removal of any vegetation on a given property that is not maintained consistent with the standards of this section. Following written notice, the Fire Chief may prescribe a procedure for the removal of such vegetation and seek reimbursement from the property owner for work that was done consistent with the procedures prescribed in the Code.



MONTECITO FIRE PROTECTION DISTRICT

95 San Ysidro Rd * Santa Barbara, California 93108 * (805) 969-7762 * FAX (805) 969-3598

IV Environmentally Sensitive Habitat (ESH)

When performing mitigation work in ESH areas, it must be determined that fuel management activities will not result in the taking of endangered, rare, or threatened plant or animal species, nor shall archeological resources be disturbed in the course of such activities.

Selective fuel management shall be practiced to minimize the removal or clearance of dead and/or decadent native riparian vegetation to the extent feasible. Maintain native vegetation to the maximum extent possible, consistent with fuel modification requirements.

Avoid clearing vegetation during the bird breeding and nesting season (typically March 1 to August 15) in key habitat areas known to support sensitive nesting bird species. Leave live native riparian vegetation and maintain native vegetation adjacent to creeks as much as possible.

Plant materials in excess of 6 inch diameter generally are not required to be removed. It is important to minimize any disturbance of soil. Removal of non-native invasive plants is encouraged.

For clarification or advice on clearing in sensitive areas, please notify the Fire District or County of Santa Barbara Planning and Development (805) 568-2000.

V Roadway / Driveway Vegetation Clearance

1. Property owners are responsible for vegetation maintenance along private roadway / driveways and in most cases along public roads which front their property.
2. A minimum 13 ½ foot vertical clearance shall be maintained above full width of the required roadways and driveways to allow for effective response of emergency vehicles at all times.
3. Horizontal clearance of vegetation shall be maintained, at minimum, to the road right-of-way or the edge of the pavement depending on individual easements to maintain maximum traffic circulation in the event of emergency evacuation.
4. Flammable vegetation such as dead materials, annual grasses, and readily combustible fuels shall be removed for 10 feet on each side of every roadway to prevent wildfire from spreading as a result of vehicular causation (catalytic converters, sparking due to metallic/asphalt abrasion, discarded cigarettes, vehicle fires, etc.).

MONTECITO

VERY HIGH

HIGH

MODERATE











PACIFIC

SANTA BARBARA

CARPINTERIA

SUMMERLAND

LEGEND

-  Los Padres National Forest District Boundary
-  Montecito Fire District Boundary
-  SRA Boundary
-  Street Name
-  Road in Montecito Fire District
-  Mutual Aid Roads
-  Creek Water Source
-  Target Hazard
-  Evacuation Route
-  SRA Boundary



-  Very High Fire Hazard Severity Zones
-  High Fire Hazard Severity Zones
-  Moderate Fire Hazard Severity Zones

**Montecito Fire Department
Fire Hazard Severity Zones
Figure 2-1**

O C



MONTECITO FIRE PROTECTION DISTRICT

595 San Ysidro Rd * Santa Barbara, California 93108 * (805) 969-7762 * FAX (805) 969-3598

MONTECITO FIRE PROTECTION DISTRICT FIRE PROTECTION PLAN

Section 3

ACCESS REQUIREMENTS FOR ROADS AND DRIVEWAYS

Fire apparatus access roads/driveways shall be provided and maintained in compliance with Section 503 of the California Fire Code (CFC) except as amended by this Section of the adopted Fire Protection Plan (FPP).

All projects for which applications are filed or are required to be filed with the County of Santa Barbara for building permits shall require a review of the access plans for the property and shall be approved by the Fire District prior to receiving a Fire Protection Certificate or County approval for building permit issuance.

The access roadway shall be installed with road-base at minimum and have Fire District approval prior to structural framing. The finished surface shall be completed prior to final approval for occupancy clearance.

I PRIVATE ROADWAY AND DRIVEWAY STANDARDS

a. REQUIRED DRIVEWAY / ROADWAY WIDTHS:

1. SINGLE PARCEL: Driveways serving a single parcel shall have a minimum paved width of **fourteen feet**.
2. TWO TO FOUR PARCELS: Driveways/Roadways serving two to four parcels shall have a minimum paved width of **sixteen feet**.
3. FIVE OR MORE PARCELS: Driveways/Roadways serving five or more parcels shall have a minimum paved width of **twenty feet**.
4. NON-RESIDENTIAL OCCUPANCIES: For driveways /roadways serving non-residential commercial occupancies, the minimum width requirement is **twenty feet**.
5. EXCEPTIONS:

Minimum pavement width shall be fourteen feet except on occasions wherein valued monuments (e.g. large trees, boulders, etc...) might be preserved by reducing the paved width of the driveway/roadway to no less than **twelve feet** at such points.



MONTECITO FIRE PROTECTION DISTRICT

595 San Ysidro Rd * Santa Barbara, California 93108 * (805) 969-7762 * FAX (805) 969-3598

b. DRIVEWAY/ROADWAY CURVES:

Curves and bends in the road shall have a 40 foot minimum outside turning radius and have an increased minimum width of 16 feet; Refer to Figure 3a-1.

c. TURNAROUNDS:

1. Turnarounds shall be provided on all dead-end driveways 100 feet or longer.
2. All dead-end roadways /private lanes shall have a turnaround at the end. This requirement is in addition to what may be required for private driveways accessed from the lane.
3. Turnaround configuration shall be either a minimum 80 foot diameter loop or hammerhead configuration 16 feet wide by the required road width plus 56 feet, or a 16 foot wide by 28 foot deep inline rectangular area adjoining the roadway. All turnarounds shall have softened corners with 40 foot radius; Refer to Figure 3a-3.
4. Additional inline turnarounds are to be provided at 400 foot intervals along the roadway or at the Fire Chief's discretion. Minimum inline turnaround configurations shall be a 16 foot wide by 28 foot deep rectangle area adjoining the roadway with softened corners; Refer to Figure 3a-3.
5. Slope Transition: Hammerhead turnarounds shall have a maximum allowance of 5 percent slope unless otherwise approved by the Fire Chief.

d. TURNOUTS:

Turnouts shall be provided at 200 foot intervals or at the Fire Chief's discretion. Minimum turnout configuration shall be 40 foot long by 10 foot wide rectangular area plus 10 foot tapers adjoining the roadway; Refer to Figure 3a-2.

e. SLOPE / GRADE:

1. Driveway / Roadway slopes greater than ten percent shall be certified by a civil engineer.



MONTECITO FIRE PROTECTION DISTRICT

595 San Ysidro Rd * Santa Barbara, California 93108 * (805) 969-7762 * FAX (805) 969-3598

2. When driveway / roadway slopes are greater than **ten percent**, chip-seal gravel surfaces will not be permitted.
 3. When driveway / roadway slopes are in excess of **fifteen percent**, a concrete surface with broom finish shall be required as stipulated in the code.
 4. At no time shall Fire Department access exceed **twenty percent** slope.
- f. GATE INSTALLATIONS:
1. **MINIMUM CLEAR WIDTH:** Gate installations shall comply with the Code, and shall have a minimum opening clearance width of not less than the required driveway/roadway width when such driveway/roadway is required for fire department access.
 2. **EXCEPTION:** A minimum clearance of twelve feet may be allowed at the Fire Chief's discretion for driveways/roadways not requiring fire department access point or for existing gates with historical significance.
 3. **ACCESS FOR GATED COMMUNITIES:** When a single road is provided for ingress and egress, the minimum open gate width shall not be less than the required road width. When there is one road for ingress and one for egress, each gate shall have a minimum clear open width of 15 feet.
 4. **ELECTRONICALLY OPERATED GATES:** A Fire District approved key operated switch or box shall be installed at an approved location to allow for emergency response access as stipulated in the Code.
 5. **AUXILLIARY BACK-UP POWER:** All security gates shall have a means of auxiliary back-up power in the event of an electrical power outage and shall be maintained operational at all times to ensure a means of egress for residents and for fire response access in accordance with the Code.
 6. **GATE LOCATION:** Gates shall be positioned to allow for a minimum 28 foot set-back from the public right-of-way. Also, the gate shall open inward unless otherwise approved by the Fire Chief.



MONTECITO FIRE PROTECTION DISTRICT

595 San Ysidro Rd * Santa Barbara, California 93108 * (805) 969-7762 * FAX (805) 969-3598

g. BRIDGES:

1. All private driveways/roadways requiring fire access over bridges or culverts shall be constructed and maintained in accordance with AASHTO HB-17 and evaluated by a California Licensed Civil Engineer at five year intervals.
2. Bridges shall be designed for a live load sufficient to carry the imposed loads of a fire apparatus and shall carry minimum rating of twenty tons (H-20 Rating).
3. Vehicle load limits signs shall be posted at both entrances to the bridge as stipulated in the Code.

h. ANGLE OF APPROACH:

Angle of approach and departure shall not exceed 12 percent rise for a thirty foot run which is to accommodate the overall length of the District's fire apparatus.

i. SURFACE PAVING STANDARDS:

Fire apparatus access roads shall be designed and maintained to support the imposed loads of a fire apparatus and shall be surfaced so as to provide all-weather driving capabilities.

Refer to the following list of approved surfaces:

1. Asphaltic concrete pavement
2. Poured concrete
3. Chip seal, allowable for grades less than 10 percent
4. Interlocking pavers over approved compacted sub-grade
5. A mixture of 6 sacks per cubic yard using half inch pea gravel shall be used when concrete pumping is indicated. Quarter depth control joints shall be located at ten foot minimum intervals. Final surface shall be either coarse broom or burlap drag.

Note: "Grass-Crete" or "Turf Block" is not an acceptable method of paving on an access road and will not be permitted in the District.



MONTECITO FIRE PROTECTION DISTRICT

595 San Ysidro Rd * Santa Barbara, California 93108 * (805) 969-7762 * FAX (805) 969-3598

6. Please refer to Figures 3-1, 3-2, 3-3 and 3-4 for illustrations of the above driveway/roadway limitations.

II MINIMUM ROADWAY REQUIREMENTS DURING CONSTRUCTION

Prior to structural framing a five inch thickness of Class II road base compacted to 95% relative compaction shall be installed to cover the required access way. A single application of liquid asphalt emulsion sealcoat shall then be applied to this surface. Prior to final surfacing the base shall be re-compacted after any contaminated surplus is removed.

III SITE MAP DESIGN SUBMITTAL

Prior to a building permit approval, the Fire District shall receive a site map showing the emergency access route is in compliance with District standards as presented in Section 3 of the adopted Montecito Fire Protection Plan. Depending on complexity of the access route, drawings may require certification by a California Licensed Civil Engineer as determined by the Fire Chief.

IV DRIVEWAY / ROADWAY MAINTENANCE

- a. The property owner shall be responsible for maintenance of private driveway/roadways. In receiving final occupancy clearance the property owner agrees to the following conditions:
 1. Driveways/roadways shall be kept clear of all obstructions. Parking shall be prohibited along private access routes and in areas designated as turnouts and turnarounds.
 2. The Fire District reserves the right to require the posting of approved signage to maintain roadway clearance at any time during this occupancy.
 3. A minimum 13 ½ foot vertical clearance shall be maintained above the required clear width of all required access roadways.
 4. The Fire District shall be indemnified and held harmless for any damage to roadways resulting from Fire District use.
 5. Fog-seal coating shall be applied at three-year intervals on all surfaces other than concrete or pavers.



MONTECITO FIRE PROTECTION DISTRICT

595 San Ysidro Rd * Santa Barbara, California 93108 * (805) 969-7762 * FAX (805) 969-3598

6. Chip-seal surfacing shall be applied at nine-year intervals on all surfaces other than concrete.
7. All bridges shall be surveyed by a licensed California Civil Engineer at five year intervals. H-Rating of twenty tons shall be required and maintained.
8. The above maintenance responsibility shall be an obligation of successor in interest.

V ADDRESS IDENTIFICATION

- a. New and existing buildings shall have approved address numbers, building numbers, or approved building identification placed in a position that is plainly legible and visible from the street or road fronting the property. Address numbers identifying all residences shall also be posted at forks in the road and other designated areas which make it obvious for emergency vehicles to locate the correct occupancy.
- b. Address identification shall be Arabic numbers or alphabetical letters and be a minimum 6 inches contrasting with the background.

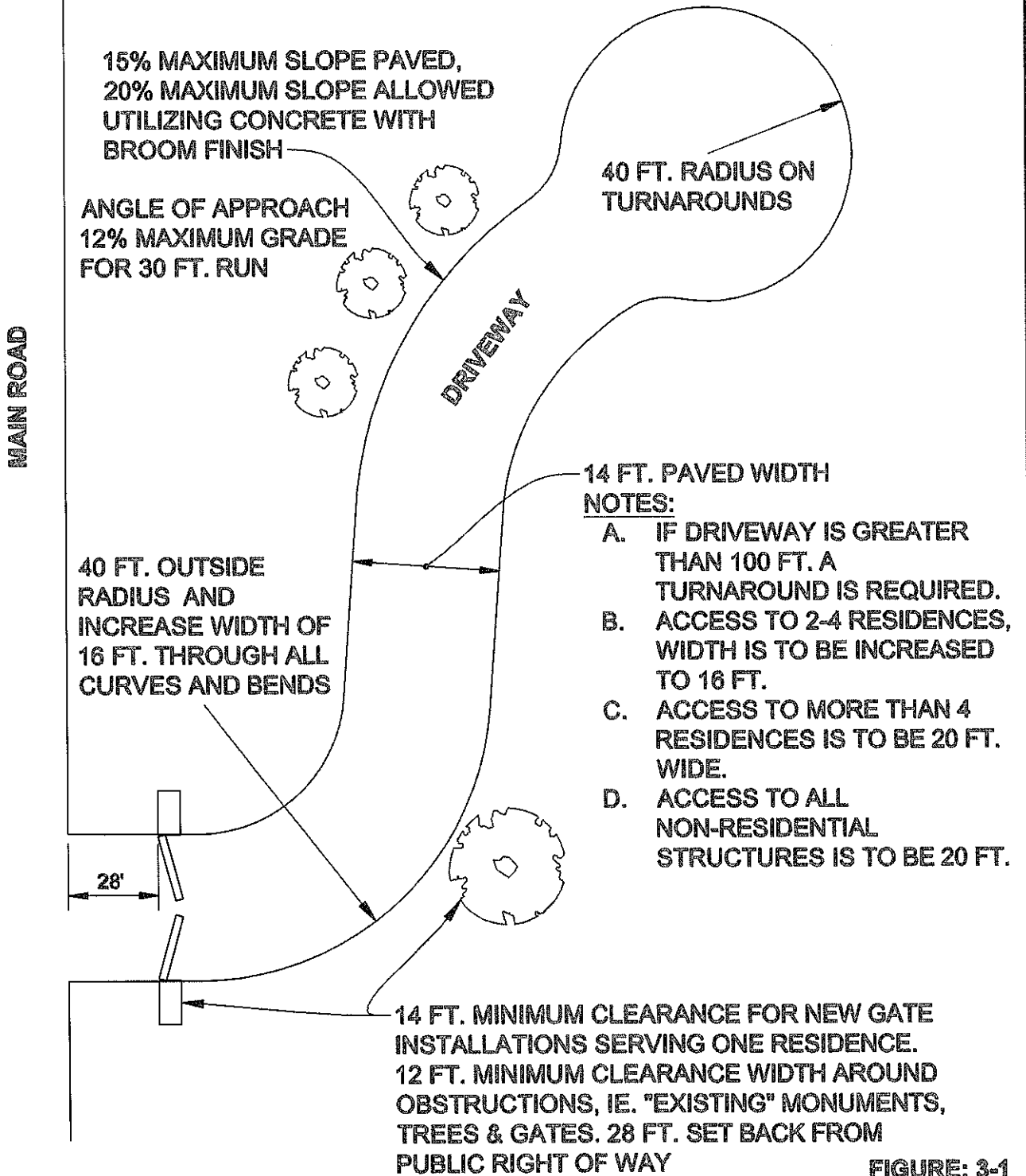
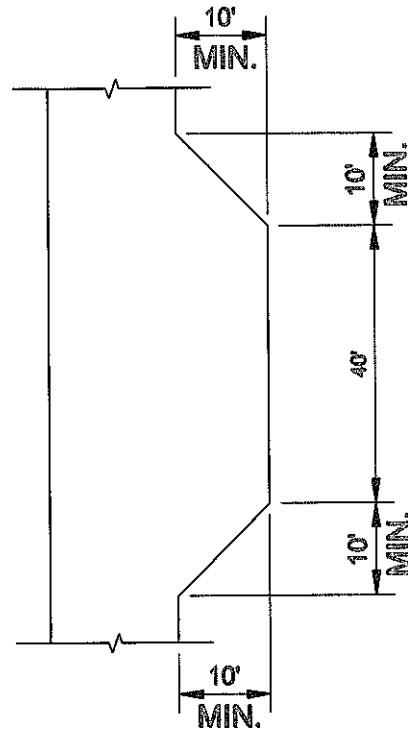

FIGURE: 3-1

ACCESS TO A SINGLE RESIDENCE

MONTECITO FIRE
DEPARTMENT

ADDITIONAL TURNOUTS SHALL BE PROVIDED AT 200 FT. INTERVALS



NOTE: PRESCRIBED PAVING WIDTHS DO NOT ALLOW FOR ROADSIDE PARKING. VERTICAL CLEARANCE ABOVE ACCESS SHALL BE MAINTAINED AT 13½ FT. MINIMUM.

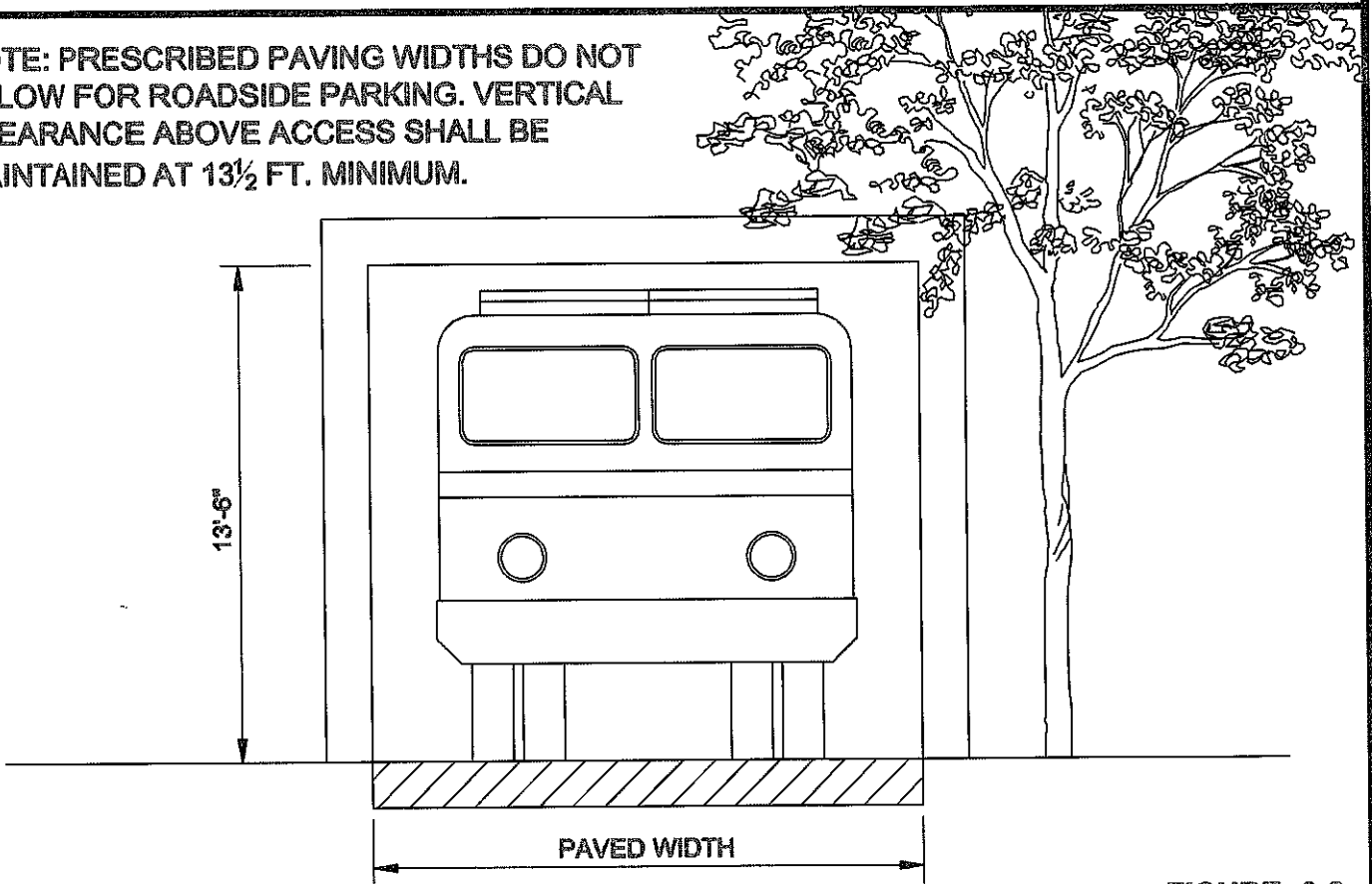
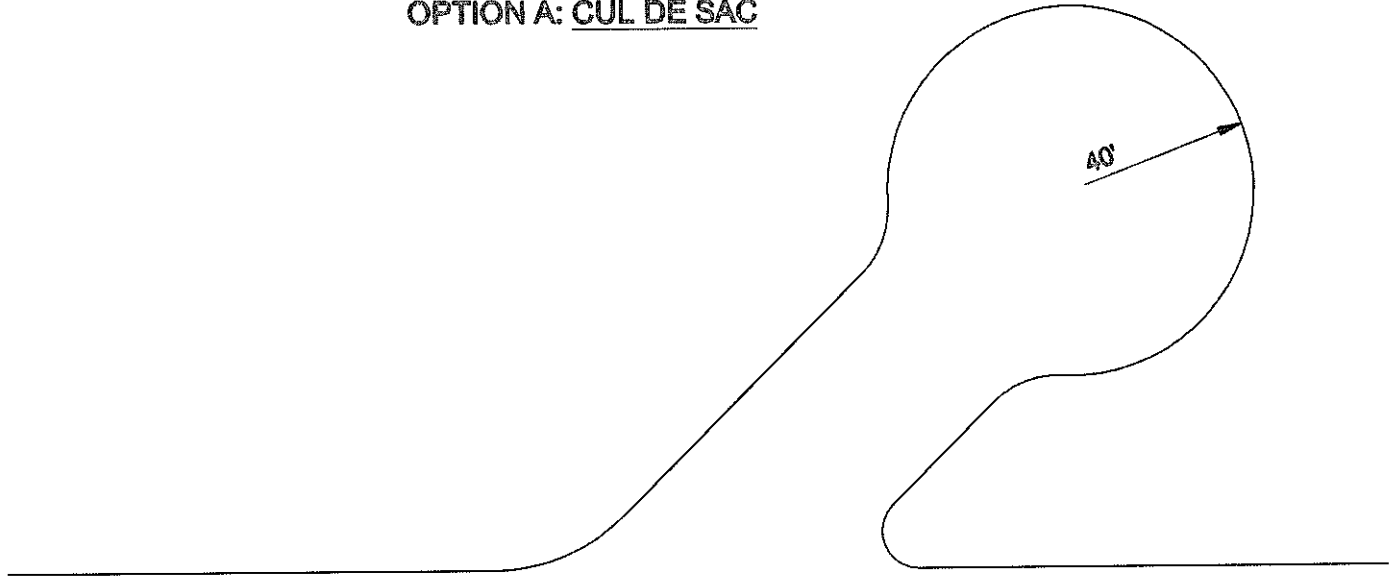

FIGURE: 3-2

TURNOUTS / VERTICAL CLEARANCE

MONTECITO FIRE DEPARTMENT

OPTION A: CUL DE SAC



STREET

OPTION B: HAMMERHEAD

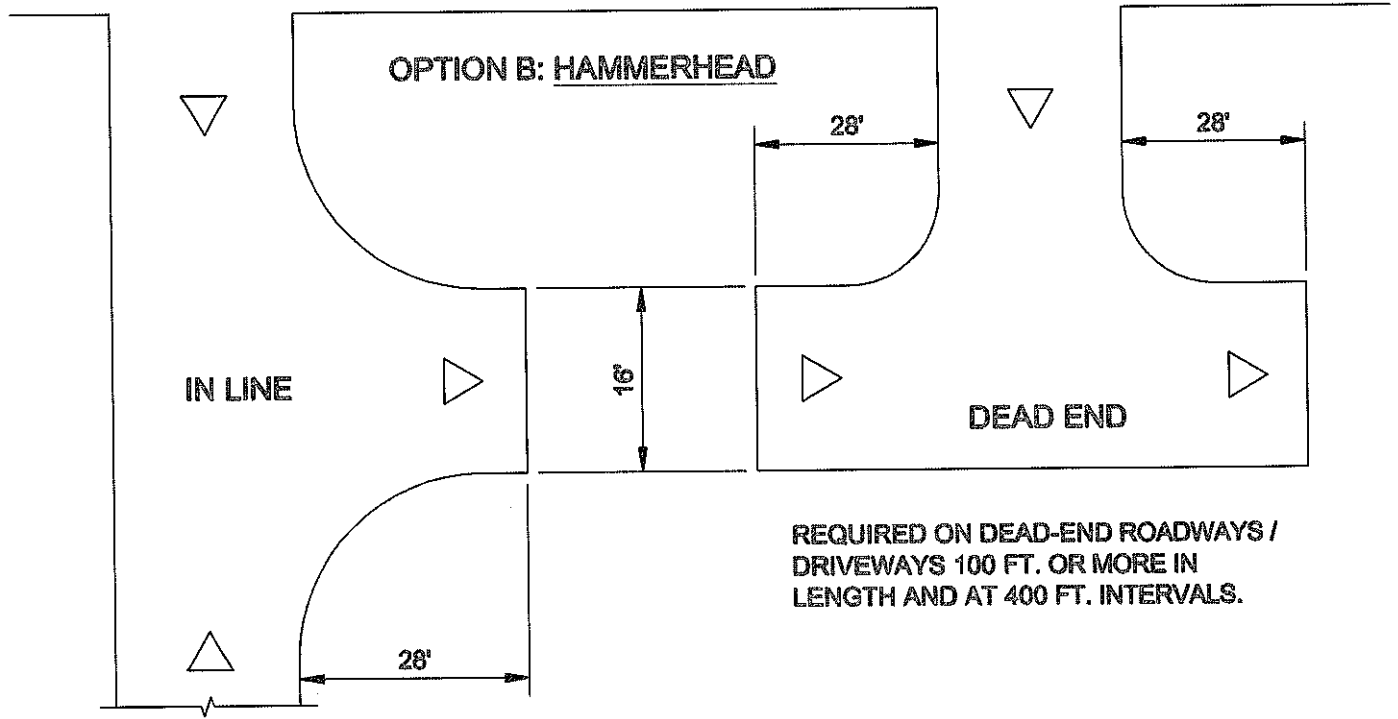
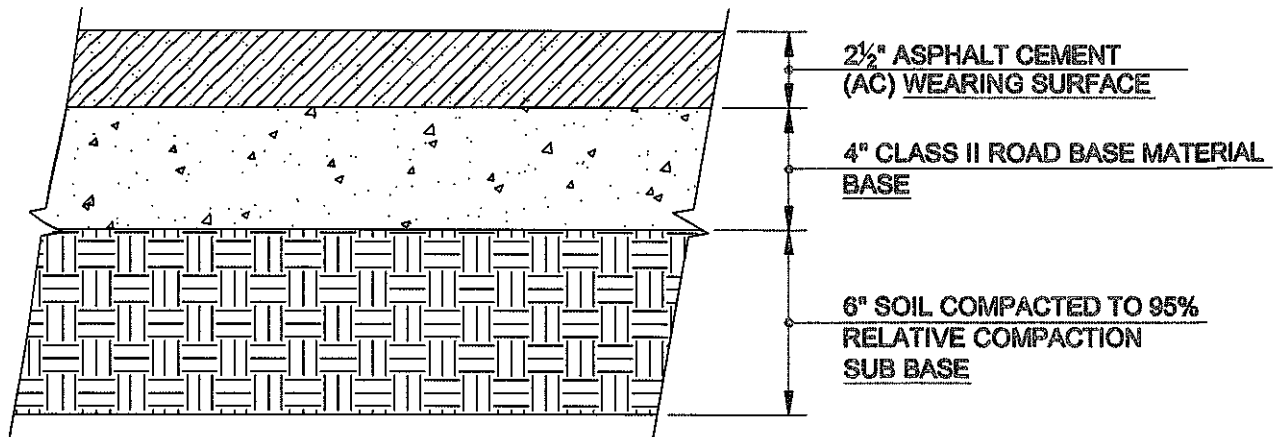

FIGURE: 3-3

TURNAROUNDS

MONTECITO FIRE DEPARTMENT

STANDARD ASPHALT PAVING (WATER IMPERMEABLE)



- NOTES: A) ALL REQUIRED ACCESS MUST SUPPORT A 20 TON FIRE APPARATUS UNDER ALL WEATHER CONDITIONS.
B) ALL REQUIRED ACCESS MUST BE IN PLACE AHEAD OF STRUCTURAL FRAMING.

FIGURE: 3-4

PAVING SPECIFICATIONS

MONTECITO FIRE
DEPARTMENT



MONTECITO FIRE PROTECTION DISTRICT

595 San Ysidro Rd * Santa Barbara, California 93108 * (805) 969-7762 * FAX (805) 969-3598

MONTECITO FIRE PROTECTION DISTRICT FIRE PROTECTION PLAN

Section 4a

WATER SUPPLY FOR FIRE PROTECTION

It is the policy of the Montecito Fire District to require adequate water supply as described within this standard to all proposed buildings and occupancies within the Fire District. Substantial reductions in the water supply required for effective fire protection are afforded to property owners within the District by means of automatic fire sprinkler installation (when required) and by the progressive application of firefighting foam technologies by the Fire District in its fire ground operations.

Water supply for fire protection is premised upon minimum available fire flows as stipulated in the Code. Through the implementation of firefighting foams the Fire District realizes the opportunity to effectively reduce such fire flows by fifty percent. Thus, required flow may be approximated by multiplying the square root of building's floor area by 13. Building floor area shall be defined as that area included within the surrounding exterior walls of a building exclusive of courtyards. Garages are to be considered as a part of the calculated building area. Detached buildings within thirty feet of one another which are located on the same parcel shall be considered a single building area. The Fire District will accept a further reduction in required fire flow of fifty percent when the building is improved with an automatic fire sprinkler system approved by the Fire District. However, in no case will the flow be less than **500 gallons** per minute at **twenty pounds per square inch (psi) residual pressure**.

The required fire flows shall be from fire hydrants and water main extensions which meet all requirements of the water purveyor. Any proposed dwelling, residential addition/alteration, or structural replacement shall have sufficient hydrants to deliver the required fire flow within **500 feet** fire apparatus travel distance of the principal entrance or access point to the structure; (Refer to Figure 4a-2). This travel distance may be extended up to a maximum of **700 feet** for sprinklered single family residential construction. For any non-residential occupancy, the required fire flow shall be delivered from hydrants located within a **300 foot** travel distance of the principal entrance. A minimum clearance of three feet in all directions shall be maintained around all required hydrants.

The Fire District shall receive a letter from the water purveyor which verifies financial arrangements for hydrant and main installations when such improvements are required within fourteen days of fire protection certificate issuance. The work needed to provide this required water supply shall be installed, operational, and have Fire District approval prior to structural framing.

Flow testing may be required by the Fire District prior to the acceptance of required hydrants. Flow determinations will be developed by the water purveyor upon request of the project applicant. Resulting flows must be consistent with the flow criteria stipulated in this Standard. Upon the successful completion of this testing, or the waiver thereof by the Fire Chief, the contractor may then proceed with structural framing.

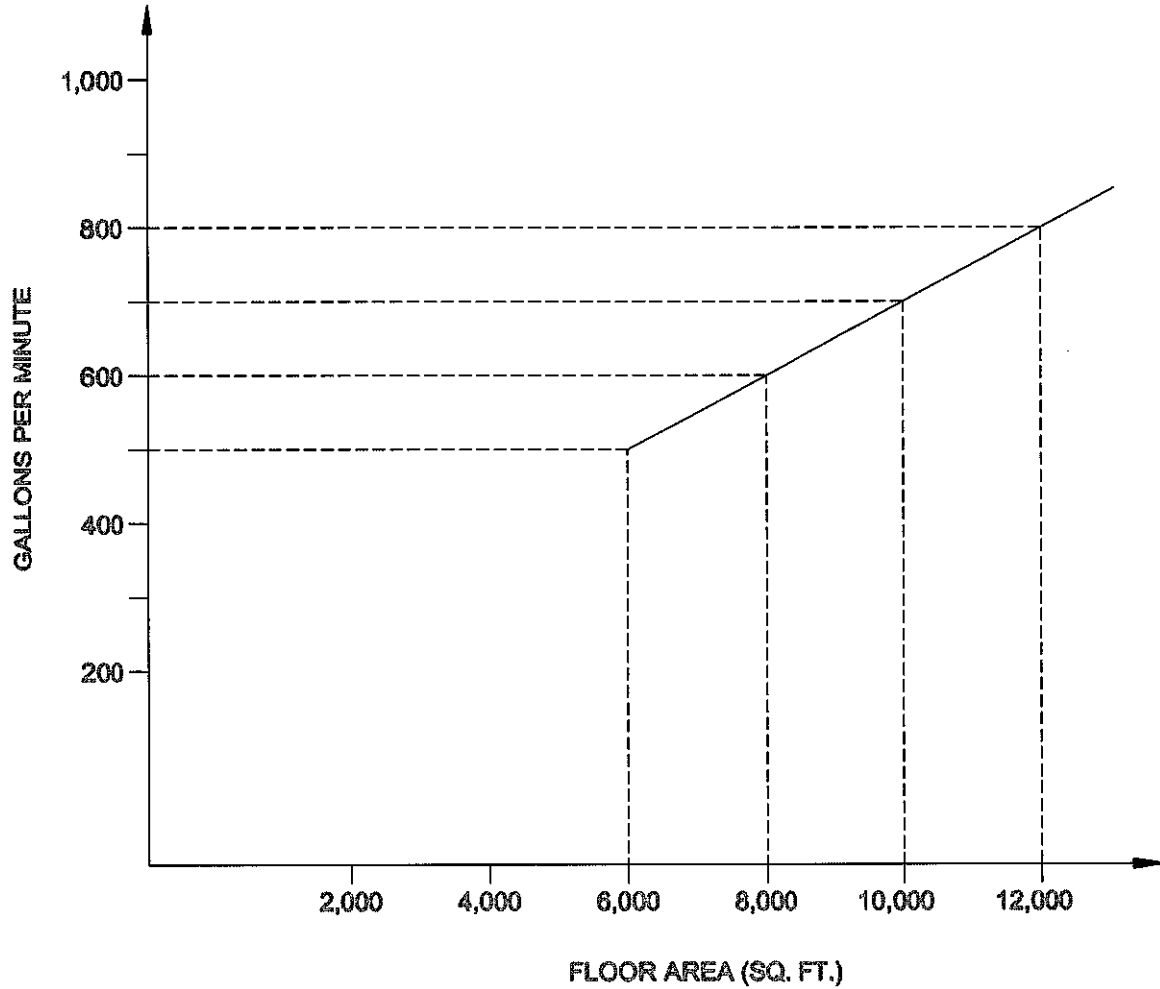

GALLONS PER MINUTE (GPM) = FLOOR AREA / 13

-50% FURTHER FLOW REDUCTION FOR FIRE SPRINKLERS SHOWN IN GRAPH ABOVE

-MINIMUM REQUIRED FLOW OF 500 GPM @ 20 PSI RESIDUAL

FIGURE: 4a-1

WATER SUPPLY REQUIREMENTS

**MONTECITO FIRE
DEPARTMENT**

200 FT. MAXIMUM DISTANCE FROM
ACCESS POINT TO THE MOST REMOTE
PART OF A RESIDENTIAL STRUCTURE
(150 FT. NON-RESIDENTIAL)

PROPOSED STRUCTURE

FIRE APPARATUS
AT ACCESS POINT

TRAVEL DISTANCE FROM ACCESS POINT
TO FIRE HYDRANT:

- 300 FT. - NON RESIDENTIAL
- 500 FT. - RESIDENTIAL
- 700 FT. - RESIDENTIAL WITH FIRE
SPRINKLERS

ACCESS DRIVE

FIRE HYDRANT

FIGURE: 4a-2

FIRE APPARATUS ACCESS
TRAVEL DISTANCE FROM HYDRANT

MONTECITO FIRE
DEPARTMENT



MONTECITO FIRE PROTECTION DISTRICT

595 San Ysidro Rd * Santa Barbara, California 93108 * (805) 969-7762 * FAX (805) 969-3598

MONTECITO FIRE PROTECTION DISTRICT FIRE PROTECTION PLAN

Section 4b

WATER STORAGE FOR FIRE PROTECTION

It is the policy of the Montecito Fire District that tank storage of water for firefighting purposes shall be limited to those instances wherein the water purveyor is unable to provide adequate fire flow from its distribution system. All structures to be served from such stored water systems shall be fitted with automatic fire sprinkler systems which comply with the standards of the Fire District as referenced in the National Fire Protection Association (NFPA) Standards 13d, 22, 24 and the Montecito Fire Protection Plan Section 3.

Plans and specifications drawn by a California Licensed Civil Engineer shall be submitted to the Fire District for review and approval prior to installation of the storage system. These plans shall include valve and piping schedules, grade lines, tank specifications, pump curves and specifications, engineer's certifications (where applicable) and scaled system drawings prior to installation of system components. All work shall be inspected prior to being covered up. The system shall be installed and operational prior to the beginning of structural framing.

The tank system shall be configured such that the required fire flow adequately provides necessary fire protection for a given sized structure as indicated on Figure 4a-1 of this Plan. The **minimum fire flow tank capacity is 5,000 gallons for up to a 2,500 square foot structure.** For every square foot increase in floor area, an increase of 2 gallons of fire flow capacity is required. The table below will be utilized to determine tank capacity for fire flow capacity. **A minimum pressure of 20 psi shall be provided at the system discharge outlets.** The following table may be used as a guide in tank sizing:

Building Size Gallons

| | |
|--------------------------|--------|
| Up to 2,500 sq. ft..... | 5,000 |
| Up to 3,000 sq. ft..... | 6,000 |
| Up to 4,000 sq. ft..... | 8,000 |
| Up to 5,500 sq. ft..... | 11,000 |
| Up to 7,500 sq. ft..... | 15,000 |
| Up to 10,000 sq. ft..... | 20,000 |



MONTECITO FIRE PROTECTION DISTRICT

595 San Ysidro Rd * Santa Barbara, California 93108 * (805) 969-7762 * FAX (805) 969-3598

Shared stored water systems may be utilized where the cumulative square footage of the structures meets requirements stated in the table above. This provision must be approved by the Fire Chief on a case by case basis; Refer to Figure 4b-1 for an illustration of such shared system.

The Fire District will permit property owners to utilize a single tank for supplying both required flows for fire protection and domestic use providing the minimum capacity for fire flow listed above is maintained in the water tank at all times.

Tanks should be from an ICBO (International Conference of Building Officials) recognized manufacturer and shall be installed in accordance with the manufacturer's installation instructions. Appropriate permits shall be obtained from the County as required. Any proposed deviation for these criteria shall be reviewed for structural integrity by and shall bear the stamp and signature of a California Licensed Structural Engineer.

The tank discharge outlet shall have a screen mesh with a minimum nominal size of four (4) inch and be of brass No. 10 B&S (Brown and Sharpe) gage wire.

Above ground piping shall be in compliance with NFPA Standard 20. Underground system piping installation shall conform to NFPA Standard 24.

A four inch class 150 full port shut off valve shall be installed in a locked open position at or near the tank outlet.

When required to achieve necessary fire flow, a centrifugal pump shall be installed and maintained as per NFPA Standard 20. Pump fittings and trim shall include isolation valves, strainer, check valve, pressure relief valve, pressure gauge, mercoid type pressure switch, and adequate provisions for vibration isolation.

System discharge outlet shall be a hydrant by J. Jones all bronze No. 3700 (or district approved equal) with 2 ½ and 4 inch National Standard Thread outlets. Outlet caps shall be bronze. Hydrant shall be installed with a class 51 ductile iron bury and a break off spool. Prior to final acceptance this hydrant shall receive two coats of yellow alkyd gloss paint.

It is to be understood that this system shall be maintained in an operative condition at all times by the property owner for the duration of any occupancy. The Fire District shall be afforded the opportunity to conduct tests of the system when reasonable advance notice is provided. Further, the Fire District shall be notified immediately should the system become inoperative at any time. It shall be the contractor's responsibility to provide a written affidavit that the property owner has been informed of this stipulation before final occupancy clearance will be granted.

EXAMPLE:

ELEVATED WATER TANK WITH AUTOMATIC REFILL DEVICE, 5,000 GALLONS MINIMUM CAPACITY. DOMESTIC STORAGE OUTLET SHALL BE LOCATED ABOVE THE 5,000 GALLON MINIMUM CAPACITY.

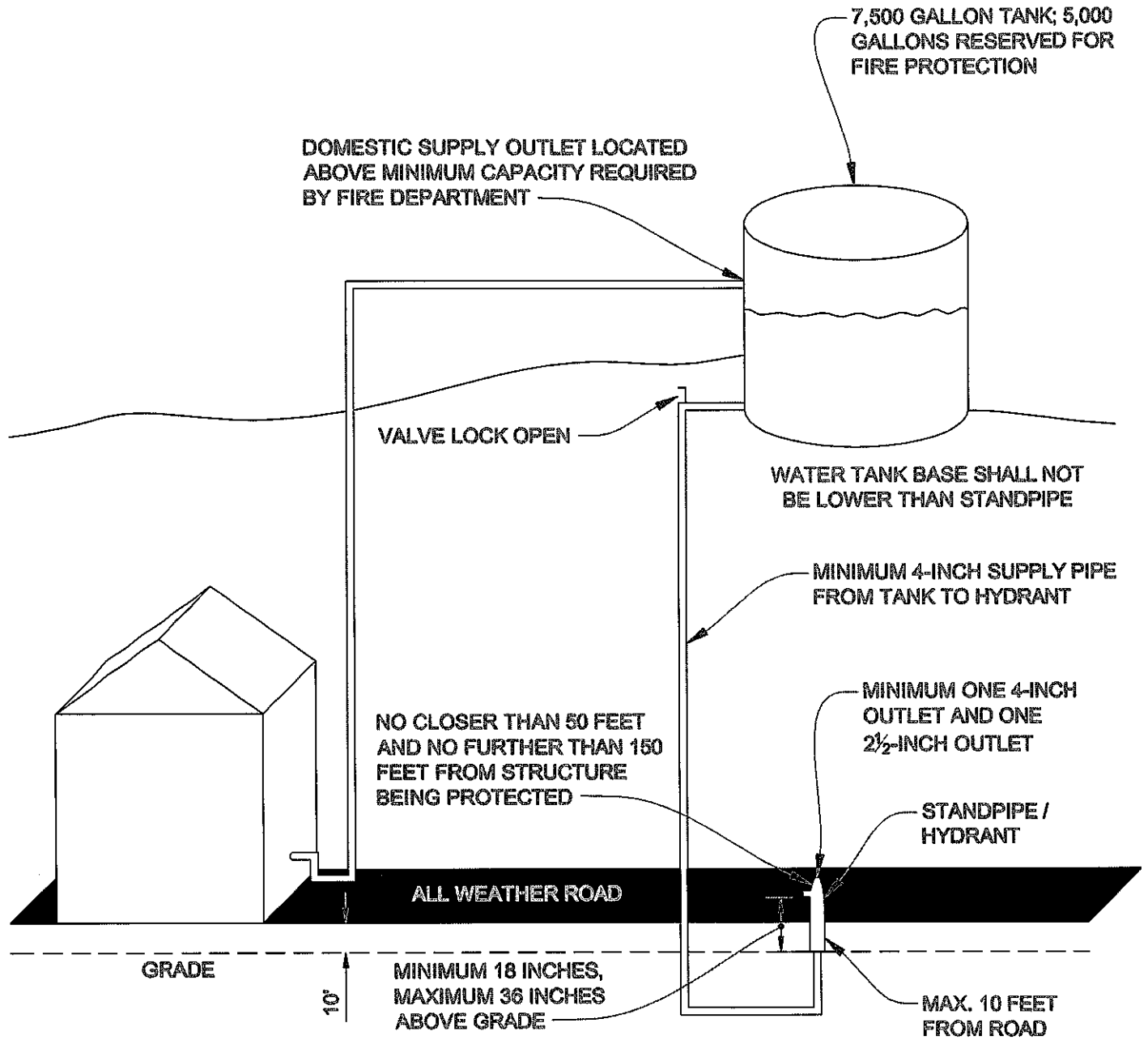

FIGURE: 4b-1

SINGLE TANK SUPPLYING FIRE PROTECTION AND DOMESTIC USE

MONTECITO FIRE DEPARTMENT



MONTECITO FIRE PROTECTION DISTRICT

595 San Ysidro Rd * Santa Barbara, California 93108 * (805) 969-7762 * FAX (805) 969-3598

MONTECITO FIRE PROTECTION DISTRICT FIRE PROTECTION PLAN

Section 5a

Residential Automatic Fire Sprinkler System Installations

I Automatic Fire Sprinkler System Standards

1. Definition and Standard: An automatic fire sprinkler system is an integrated system of underground and overhead piping designed and installed in accordance with fire protection engineering standards (reference standards) as may from time to time be adopted by the District. The system shall include one or more automatic water supplies. These reference standards may include:
 - a. Standards 13, 13D, 13R, and 24 as developed and published by the National Fire Protection Association;
 - b. California Fire Code and California Residential Code Standards as developed and published by the International Code Council, Inc. and the California Building Standards Commission;
 - c. Sections 5a and 5b of the District's Fire Protection Plan as may be amended from time to time.

II When Residential Fire Sprinkler Systems are Required

1. Locations Required: Notwithstanding any other requirement of the Code of the County of Santa Barbara, and except as otherwise provided in this Section, automatic fire sprinkler systems shall be installed in and maintained in all occupancies and locations set forth as follows:
 - a. It is the policy of the Fire District to require an approved residential fire sprinkler system in all new one and two family dwellings and townhouses as stipulated in the Code.
 - b. Any new building for which application for building permits are filed or are required to be filed with the County of Santa Barbara regardless of square footage.



MONTECITO FIRE PROTECTION DISTRICT

595 San Ysidro Rd * Santa Barbara, California 93108 * (805) 969-7762 * FAX (805) 969-3598

- c. Existing Residential Structures: Additions or modifications to existing residential buildings or structures for which applications for building permits are filed or are required to be filed with the County of Santa Barbara, which are modified to increase or replace portions of the gross floor area to 3500 square feet or more and the aggregate structural alteration / addition is greater than 1000 square feet in gross floor area cumulative, then the District shall require installation of an automatic fire sprinkler system throughout the entire residential building or structure.
 - (ii) For the purpose of measuring cumulative square footage, the District shall include all additions or modifications occurring on or after October 16, 1991.
 - (iii) Separate buildings such as detached garages, cottages, auxiliary structures, that are located within 30 feet of the main structure shall be included in the overall accumulative total of gross square footage of the main residence.
- d. Buildings: Separate buildings such as garages, cottages, pool house, cabana's, auxiliary structures, etc...shall require approved residential sprinkler systems under this standard.
- e. All buildings and structures for which applications for building permits for additions and or structural alterations are filed with the County of Santa Barbara County which are not served by water supplies meeting District standards or are served by stored water systems.
- f. Residential structures over 10,000 square feet of living area shall require sprinkler installations per NFPA 13R.

III Residential Fire Sprinkler Guidelines for Plans Submittal

- I. The property owner shall submit three (3) sets of plans, data sheets, and calculations for the proposed sprinkler system to the Fire District for review and approval prior to installation. Plans shall include the information:
 - a. Property owner
 - b. Address of property
 - c. Assessor's Parcel Number (APN)
 - d. Plot map indicating all structures, water meter location and size, underground pipe size, point of connection, length and type of pipe to be installed.



MONTECITO FIRE PROTECTION DISTRICT

595 San Ysidro Rd * Santa Barbara, California 93108 * (805) 969-7762 * FAX (805) 969-3598

- e. Proposed installation company: Include contact information along with State Contractors License number.
 - f. Full height cross section showing beamed ceilings, vaulted ceilings, attic areas, and sub-floor basements.
 - g. Riser Detail: Indicating double check valve assembly, pressure gauge, drain valve, flow switch, pressure relief valve, hammer arrester, domestic water control valve.
 - h. Detailed Hydraulic Calculations: One copy
 - i. Sprinkler head spacing
 - j. Show all non-sprinklered areas
 - k. Indicate manufacture, style, sprinkler model orifice size a “K” factor for each sprinkler used.
 - l. Pipe information: type and size
 - m. Hanger detail
 - n. Inspectors test valve
 - o. Identify each room and space of the buildings
 - p. Location of heat sources: Fireplaces, ovens and cook tops, heating devices, FAU.
 - q. Water flow information: Static pressure, residual pressure, flow.
2. The following shall appear on each sheet of required shop drawings: “I certify that this sprinkler system is in full compliance with the design criteria of the Montecito Fire Protection Plan”. This note shall appear along with the sprinkler contractor’s dated signature and seal.
 3. Approved shop drawings shall be maintained on the job site during all phases of system installation. Any field changes shall be noted on the drawings. The edited drawings shall be submitted to the Fire District prior to final Fire District approval.
 4. Copies of Manufacturer’s data for all installed system components shall be provided upon Fire District request prior to final system acceptance. All system components shall be installed following manufacturer’s guidelines unless specific relief is granted by the Fire Chief.
 5. Listed and Labeled: Only UL listed and labeled devices and materials shall be installed and used in accordance with the listing limitations and manufactures guidelines. Only new sprinkler heads and components shall be installed in the systems.



MONTECITO FIRE PROTECTION DISTRICT

595 San Ysidro Rd * Santa Barbara, California 93108 * (805) 969-7762 * FAX (805) 969-3598

IV Water Supply

1. Water Supply: All connections to domestic water supply shall be made in accordance with applicable codes and standards of the County and any local water purveyor.
2. Water Supply Main: All residential sprinkler systems shall have a single supply main from the meter serving both domestic demand and the sprinkler system. A dedicated main solely for sprinkler system may be required on a case by case basis.
3. Domestic Water Supply Shut Off: Domestic water supply shut off valve on the supply line shall be installed on the domestic side of the sprinkler system riser (system plumbing including flow switch and valves). This is to assure the sprinkler system remains in service when domestic supply is shut off.
4. Riser Location: Separate system risers may be installed remote from the domestic water source however must be easily located outside of the building.
5. Conceal Riser: All system risers shall be installed on the outside of the building unless otherwise approved by the Fire Official to conceal the riser in walls, basements, etc...
6. Water Supply: Domestic water supply must be connected to the fire sprinkler system at rough inspection.
7. Alarms: All sprinkler systems shall have a minimum six inch exterior bell mounted and linked to the system flow switch and shall be monitored by an approved alarm service.
8. Back Flow Prevention: For back flow prevention, an approved double check valve assembly shall be installed at system riser.
9. Sprinkler System Shut Off: Shut off valves shall be installed on each side of the double check valve and shall be chained and locked in the open position prior to final system acceptance.
10. Water Hammer Arrestor: An approved water hammer arrestor shall be installed on the sprinkler system riser when water supply is provided by from the local water purveyor. This component shall be located on the supply side of the system flow switch.



MONTECITO FIRE PROTECTION DISTRICT

595 San Ysidro Rd * Santa Barbara, California 93108 * (805) 969-7762 * FAX (805) 969-3598

11. Pressure Relief Valve: An approved poppet type pressure relief valve shall be installed between the required backflow prevention device and the system flow switch. Design pressure shall not be greater than 160 psi. A pressure regulator shall be installed where incoming pressures are in excess of 160 psi.
12. Domestic Water Demand: System hydraulic design shall provide for an allowance of five gallons per minute (GPM) for domestic demand.
13. Inspector's Test Valve: Property owner shall install non-threaded one-half inch ball valve at the remote area of the system to serve as the inspector's test valve. This same type of valve shall be located at the riser to serve as a system drain. Any threads on these outlets are to be removed.
14. Flow Testing the System: Flow rate is measured for a thirty second period and shall conform to the manufacturer's listing criteria for the installed sprinkler heads plus an additional 5 GPM for domestic supply. Contractors shall provide all equipment necessary for conducting this test.
15. Automatic Booster Pump: When domestic water supply pressure is insufficient to produce enough water flow and pressure to accommodate a fire sprinkler system, a booster pump can be integrated into the system to augment domestic and fire flow demand.

V Sprinkler Riser System Components

1. All risers shall be easily located, preferably on the outside of the building in plain sight. Risers may be installed in an access panel on an outside wall with permanent labeling on the door. Alternate locations to this standard must have prior approval by the Fire Official.
2. The system riser shall branch off the domestic supply line on the supply side of the main shut off valve. This is to assure the sprinkler system remains operable when the domestic supply is shut off.
3. All risers shall be built with copper piping and all shut off controls shall be ball valve design.
4. Check Valve: For back flow prevention, an approved double check valve assembly shall be installed on the system riser.
5. Sprinkler System Control Valves: There shall be two shut off ball valves located on each side of the double check valve. These valves shall be locked in the open position upon final inspection.



MONTECITO FIRE PROTECTION DISTRICT

595 San Ysidro Rd * Santa Barbara, California 93108 * (805) 969-7762 * FAX (805) 969-3598

6. Gauge: A UL listed 300psi gauge shall be installed.
7. Pressure Relief Valve: An approved poppet type pressure relief valve shall be installed on the riser and located between the back flow device and the system flow switch. Device shall be set with a with a design pressure of 160 psi.
Note: This valve will not be required when sprinkler system is supplied from a gravity fed stored water system.
8. Hammer Arrester: An approved hammer arrester shall be installed on the riser when water supply to the system is provided from the local water purveyor.
9. Drain Valve: An unthreaded 1/2 inch ball valve shall be installed on the system and positioned such that flow will be to the outside away from the building.
10. Flow Switch: A system flow switch shall be installed and have the capability of a 90 second delay. It shall be equipped with two connections; one for a local exterior 6 inch bell and one for alarm system monitoring. All flow switches shall be set for a 30 second delay.
11. Signage: All sprinkler system shutoff valves shall have an all weather sign affixed identifying the buildings they serve.
12. Alarms: Each sprinkler riser shall have a minimum 6 inch alarm bell affixed to an exterior wall of the structure positioned such that it can be heard by closest neighbor when activated.

VI Residential Sprinkler System Design

1. Piping: The following list of approved piping is acceptable to use in residential fire sprinkler systems installations: Type "M" copper, Type "L" copper, steel pipe, and Chlorinated Polyvinyl Chloride (CPVC) plastic.

(ii) Note: Type "K" copper pipe is unacceptable to use
2. Hanging Methods: All piping shall be provided with approved hangers and supported per manufactures requirements. Refer to Standard VII of this section for further information on hanging pipe.
3. Sprinklers: Only new residential sprinklers shall be installed unless otherwise indicated in the Code. Sprinklers shall only be installed according to their listing. When construction parameters exist that prevent listed sprinklers from being installed, sprinklers may be installed out of their listing when a three head calculation is provided and tested on site.



MONTECITO FIRE PROTECTION DISTRICT

595 San Ysidro Rd * Santa Barbara, California 93108 * (805) 969-7762 * FAX (805) 969-3598

4. Sprinklers in Beams: Listed beam sprinklers shall be installed a maximum 16 feet apart with beam depths up to 14 inches. Sprinklers shall be installed in beam pockets when beams exceed 14 inches in depth.
5. Attics: A single intermediate temperature upright sprinkler head shall be located within six inches of the roof ridge beam in each discrete attic area or at 30 foot maximum intervals along any main piping.
6. Exterior Porches: All roof lines, canopies, porches, patios, and overhangs that exceed 4 feet in length shall have intermediate sprinkler heads spaced per listing requirements.
7. Forced Air Units (FAU): A single intermediate temperature sprinkler shall be installed over each individual FAU. When there is more than one FAU in a single location, sprinkler heads shall be spaced as per Ordinary Hazard.
8. Water Heater Closets: All water heater closets regardless of size require fire sprinklers.
9. Closets: Closets that exceed three feet in depth or any that have light fixtures installed are required to have sprinklers.
10. Garages and Open Carports: Garages and open carports shall be protected with intermediate temperature commercial sprinklers spaced a maximum 100 square feet apart.
11. Bathrooms and Saunas: All bathrooms, regardless of size, shall be protected with sprinklers. Sauna rooms shall be protected with 286 degree sprinklers.
12. Crawl Spaces and Attics: Crawl spaces with concrete floors and any attic spaces intended for storage shall have sprinklers spaced accordingly with cage protectors.
13. Mechanical Rooms: Intermediate temperature sprinkler heads are required and spaced for ordinary hazard with cage protectors.
14. Elevator Shafts: One intermediate sprinkler head shall be installed near the bottom of the shaft.
15. Heat /Return Air Registers: Sprinklers shall be located no closer than two feet from any register.



MONTECITO FIRE PROTECTION DISTRICT

595 San Ysidro Rd * Santa Barbara, California 93108 * (805) 969-7762 * FAX (805) 969-3598

16. Ceiling Fans and Large Light Fixtures: Sprinklers shall be installed on both sides on a surface mounted fan or light fixture to prevent blocking the spray pattern.
17. Heads shall be located a minimum eighteen inches away from any HVAC diffuser grille.
18. Pendant head diffusers may be located a maximum of eight inches below the finished ceiling level. A three head design will be required for any system installed in barreled, coffered, exposed beam or cathedral type ceilings.
19. Sprinkler spray patterns shall not be obstructed and all head clearances shall be provided as required by NFPA 13D
20. Property owner shall install non-threaded 1/2 inch ball valve at the remote test connection as an inspector's test valve and at the riser as a system drain valve. Any threads on these outlets are to be removed.

VII Sprinkler Pipe Installation Requirements

1. Copper Pipe

- a. All materials delivered to the job site shall be protected from the physical elements and damage. Any damaged, gouged, cut, scratched heads, pipe or fittings shall be removed and replaced.
- b. No corrosive or self cleaning fluxes shall be used. Joints shall be wiped clean of excess flux and solder.
- c. All piping running through studs or masonry shall be protected by elastomeric or plastic sleeves at three foot maximum intervals.
- d. Nails are unacceptable as a means of securing hangers and supports. Piping shall be supported at the following maximum intervals:
 - Within six inches of all sprinkler drops
 - Within eighteen inches of all joints
 - Within four foot intervals on CPVC piping
 - Within six foot intervals on copper tubing
- e. Hangers: Refer to local plumbing codes for acceptable hanger types. Hangers shall be installed every twelve feet and within one foot of any sprinkler.



MONTECITO FIRE PROTECTION DISTRICT

595 San Ysidro Rd * Santa Barbara, California 93108 * (805) 969-7762 * FAX (805) 969-3598

- f. Copper pipe may be exposed in attics, porches, canopies, garages and open carports.
- g. Approved copper pipe must be utilized and protected when application calls for piping running through the sub-roof assembly just below roof decking.
- h. Approved Pipe: Type “M” copper, Type “L” copper.

2. CPVC Pipe

- a. Installers shall have attended a practical application training class by a CPVC pipe manufacture and have in possession a pocket card verifying proper certification to install this pipe.
- b. Hangers shall be approved for CPVC Pipe and installed every six feet along the length of the pipe and within six inches from sprinkler heads.
- c. CPVC pipe shall not be installed in exposed areas such as porches, canopies, garages, open carports, etc...
- d. Roofs/Vaulted Ceilings: CPVC piping shall not be installed in roofs where there is no attic space. Copper pipe shall be used in these applications and joined together with CPVC piping in the attic space.
- e. Spray Foam Insulation: CPVC pipe must be protected as per manufactures recommendations where it could come in contact with spray foam insulation. Under no circumstances is CPVC pipe allowed to be encased by this product without protection.
- f. Incompatible Materials: Materials that have been identified as incompatible with CPVC shall not be allowed to contact the pipe. Examples of such materials are Romex electrical wiring, flexible wire/cable, metallic ducting, and communication lines. Check CPVC manufacture product data sheets for a complete list of incompatible materials.
- g. Test Plugs: For CPVC piping, no sprinkler heads shall be installed in any system until the Fire Official has completed both flow test and rough inspections. At this stage of inspection, test plugs must be installed.

VIII Inspection Requirements



MONTECITO FIRE PROTECTION DISTRICT

595 San Ysidro Rd * Santa Barbara, California 93108 * (805) 969-7762 * FAX (805) 969-3598

1. Rough Inspection: Full visual inspection of all system components, piping, connections, etc...System must pass inspection before being covered.
2. Test Plugs: For CPVC piping, no sprinkler heads shall be installed in any system until the Fire Official has completed both flow test and rough inspections. At this stage of inspection, test plugs must be installed.
3. Flow/Bucket Test: Flow testing of system is required. Flow shall be measured for a thirty second flow period and shall conform to the manufacturer's listing criteria for the installed sprinkler heads from the furthest most remote area of the system. Contractors shall provide all equipment necessary for conducting test.
4. Hydrostatic Test: Each system shall be hydrostatically tested at no less than 200 psi for copper and steel systems and at 150 psi for all CPVC systems. System shall hold a desired pressure for a minimum period of two hours.
5. Final Inspection: At final inspection, fire sprinkler covers/escutcheons shall be installed. Sprinkler head box shall be mounted in plain sight in garage or mechanical room. Included in the box shall be three spare sprinkler heads per type installed in the system and a wrench sized for each type of head. Alarm system shall be connected and "on line" to local alarm monitoring service at the time of inspection. System shall be flowed and tested for operability and assurance that proper communication links are in place prior to final approval for occupancy clearance.
6. Maintenance Schedule: The sprinkler contractor shall provide the property owner with maintenance information as described in NFPA 13D. Property owner shall maintain the system consistent with these requirements



MONTECITO FIRE PROTECTION DISTRICT

595 San Ysidro Rd * Santa Barbara, California 93108 * (805) 969-7762 * FAX (805) 969-3598

MONTECITO FIRE PROTECTION DISTRICT FIRE PROTECTION PLAN

Section 5b

NON-RESIDENTIAL SPRINKLER SYSTEM INSTALLATIONS

It is the policy of the Fire District to require an approved automatic fire sprinkler system in all non-residential structures as required by the Code.

This sprinkler standard is based upon the National Fire Code Standard 13, 2013 Edition published by the National Fire Protection Association (NFPA) as may be amended from time to time. The Fire District has made the following modifications to the NFPA 13 Standard:

1. Sprinkler Contractor's shop drawings (3 sets) shall be received by the Fire District three weeks prior to any sprinkler system installation. Drawings shall meet all conditions of this Standard. All field changes shall be initialed and shown on a stamped, approved set of drawings by the job foreman. Approved shop drawings shall be maintained and retained on the job site at all times that pipe is being installed.
2. Sprinkler shop drawings shall be subject to review by a Fire District retained consultant at the Fire Chief's discretion. All costs associated with this review shall be paid for by the property owner.
3. Sprinkler Contractor's shop drawings shall be in compliance with NFPA 13 guidelines. It shall be the decision of the Fire Chief as to whether compliance has been met. Required information on the drawings shall include the following:
 - a. Cross-sectional drawings for all typical sprinklered areas.
 - b. Riser schematic details to include all valves, jointing and support bracing.
 - c. Control diagram for flow switch.
 - d. Details of all typical hanger and bracing applications for this work.
 - e. All applicable support and drainage provisions as described in NFPA 13 shall be met by the Sprinkler Contractor. Auxiliary drains shall be routed to the building exterior.
 - f. A list of all abbreviations and symbols shall be provided on the drawings.
 - g. Certification required for all welding. All welding to be indicated on shop drawings.
4. The following note shall appear on each sheet of required shop drawings: "I certify that this sprinkler system is in full compliance with the design criteria of the Montecito Fire Protection Plan". This note shall appear along with the Sprinkler Contractor's dated signature and seal.



MONTECITO FIRE PROTECTION DISTRICT

595 San Ysidro Rd * Santa Barbara, California 93108 * (805) 969-7762 * FAX (805) 969-3598

5. The sprinkler shop drawings shall bear the signature and registration number of a National Institute for Certification in Engineering Technologies (NICET) Level III sprinkler designer. At the discretion of the Fire Chief, the sprinkler designer may submit resume and credentials which demonstrate an equivalent level of expertise.
 6. Hydraulics: Maximum flow rate for any underground pipe shall not exceed 16 feet per second. Maximum flow rate for any above ground pipe shall not exceed 20 feet per second.
 7. All pipe and materials delivered to the job site shall be protected from the elements and physical damage.
 8. All penetrations of fire separation walls by sprinkler piping shall be sealed with a suitable sealant prior to final inspection.
 9. The sprinkler system shall be inspected at the following intervals:
 - a. All welded sections shall be field inspected prior to installation. All burrs, slag, and welding residue shall be filed and removed prior to inspection.
 - b. All piping shall be inspected prior to being covered, buried or concealed.
 - c. Hydrostatic testing will be required upon completion of piping installation.
 - d. Final inspection for system acceptance shall be completed prior to granting occupancy clearance. A set of approved shop drawings with all field changes shall be produced for this inspection. All components of this system shall be operational and in compliance with this Section.
- All required inspections shall be arranged to allow the Fire District 48 hours advance notice. Any work completed without the required inspections shall be removed and replaced at the discretion of the Fire Chief.
10. All underground pipe shall be bedded on a puddled and tamped 4 inch thick base of yellow sand prior to hydrostatic testing. Backfilling shall consist of an initial 12 inch lift of tamped yellow sand. Subsequent compacted lifts of 12 inches, or a fraction thereof, shall be made with clean backfill.
 11. The manufacturer's published design and installation guidelines shall prevail over NFPA guidelines. The Sprinkler Contractor shall provide all information as deemed necessary by the Fire Chief to establish evidence of compliance with the Manufacturer's guidelines.
 12. All system valves shall be UL and/or FM listed for fire sprinkler service.
 13. Any deviations from procedures described within this Standard shall be allowed only with the express written consent of the Fire Chief.



MONTECITO FIRE PROTECTION DISTRICT

595 San Ysidro Rd * Santa Barbara, California 93108 * (805) 969-7762 * FAX (805) 969-3598

MONTECITO FIRE PROTECTION DISTRICT FIRE PROTECTION PLAN

Section 6

REQUEST FOR MODIFICATIONS FOR POST DISASTER REBUILDS

The Montecito Fire Protection District recognizes the adverse impacts of disasters within our community. The Fire District is committed to working with property owners in recovering from the impacts of disaster as quickly as possible to ensure a resilient community.

Consistent with established development standards, each proposed rebuild will have a set of conditions pursuant to requirements set forth in the current California Fire Code (CFC) and the adopted Montecito Fire Protection Plan. The Fire District recognizes that when re-building communities following disasters, there may be practical difficulties in meeting requirements relevant to current code standards.

Property owners that are affected by disasters and have demonstrated difficulties making the code upgrade requirements may request a modification to the imposed conditions of the Fire Protection Certificate (FPC). The appeal for modification shall be in the form of a written request and shall contain an acknowledgement of the applicable code standards and include a description of the practical difficulties in attaining the specific requirements imposed. Further, the letter shall include a list of suggested modifications to the project that will assist the Fire District in providing the highest level of fire and life safety for the residents, their properties, and the community as a whole.

Fire District staff will convey which conditions apply specific to an individual project, both in the initial planning phase, and as condition of final approval / certificate of occupancy issuance. Site inspections and conceptual plan reviews by Fire District personnel will be made upon the request of owners or their agents.

Address the document on modification of the Fire Protection Certificate and any questions to the District Fire Marshal.



MONTECITO FIRE PROTECTION DISTRICT

595 San Ysidro Rd * Santa Barbara, California 93108 * (805) 969-7762 * FAX (805) 969-3598

MONTECITO FIRE PROTECTION DISTRICT FIRE PROTECTION PLAN

Section 6

REQUEST FOR MODIFICATIONS FOR POST DISASTER REBUILDS

The Montecito Fire Protection District recognizes the adverse impacts of disasters within our community. The Fire District is committed to working with property owners in recovering from the impacts of disaster as quickly as possible to ensure a resilient community.

Consistent with established development standards, each proposed rebuild will have a set of conditions pursuant to requirements set forth in the current California Fire Code (CFC) and the adopted Montecito Fire Protection Plan. The Fire District recognizes that when re-building communities following disasters, there may be practical difficulties in meeting requirements relevant to current code standards.

Property owners that are affected by disasters and have demonstrated difficulties making the code upgrade requirements may request a modification to the imposed conditions of the Fire Protection Certificate (FPC). The appeal for modification shall be in the form of a written request and shall contain an acknowledgement of the applicable code standards and include a description of the practical difficulties in attaining the specific requirements imposed. Further, the letter shall include a list of suggested modifications to the project that will assist the Fire District in providing the highest level of fire and life safety for the residents, their properties, and the community as a whole.

Fire District staff will convey which conditions apply specific to an individual project, both in the initial planning phase, and as condition of final approval / certificate of occupancy issuance. Site inspections and conceptual plan reviews by Fire District personnel will be made upon the request of owners or their agents.

Address the document on modification of the Fire Protection Certificate and any questions to the District Fire Marshal.

Agenda

Item #3

MONTECITO FIRE PROTECTION DISTRICT
AGENDA FOR THE FINANCE COMMITTEE MEETING

Montecito Fire Protection District Headquarters

595 San Ysidro Road

Santa Barbara, California

March 13, 2014 at 1:00 p.m.

Agenda Items May Be Taken Out Of The Order Shown

1. Public comment: Any person may address the Board at this time on any non-agenda matter that is within the subject matter jurisdiction of the Montecito Fire Protection District; 30 minutes total time is allotted for this discussion.
2. Review February 2014 financial statements.
3. Review PARS Account Summary and Correspondence.
4. Consider Resolution to donate excess equipment to Allen Hancock Fire Academy.
5. Fire Chief's Report.
6. Requests for items to be included for the next Finance Committee Meeting.

Adjournment

This agenda is posted pursuant to the provisions of the Government Code commencing at Section 54950. The date of the posting is March 6, 2014.

MONTECITO FIRE PROTECTION DISTRICT



Chip Hickman, Fire Chief

**MONTECITO FIRE PROTECTION DISTRICT
CASH IN TREASURY - ALL FUNDS
February 28, 2014**

| | Fund 3650 General | Fund 3651 Pension Obl. | Fund 3652 Capital Outlay | Fund 3653 Land & Bldg | Fund 3654 Mello-Roos | All Funds |
|----------------------------|----------------------|---------------------------|-----------------------------|--------------------------|-------------------------|----------------------|
| Cash Balance at 2/1/14 | 7,097,439.13 | 346.92 | 1,996,800.00 | 4,854,861.15 | 11,455.88 | 13,960,903.08 |
| Income: | | | | | | |
| Revenues | 15,538.09 | - | - | - | - | 15,538.09 |
| Interest | - | - | - | - | - | - |
| Other: | | | | | | |
| CSFD: Shepard Mesa Project | 16,714.15 | - | - | - | - | 16,714.15 |
| | 32,252.24 | - | - | - | - | 32,252.24 |
| Expenses: | | | | | | |
| Claims Processed | (173,851.06) | - | - | (324.50) | (1,032.50) | (175,208.06) |
| Payroll | (792,561.82) | - | - | - | - | (792,561.82) |
| | (966,412.88) | - | - | (324.50) | (1,032.50) | (967,769.88) |
| Cash Balance at 2/28/14 | <u>6,163,278.49</u> | <u>346.92</u> | <u>1,996,800.00</u> | <u>4,854,536.65</u> | <u>10,423.38</u> | <u>13,025,385.44</u> |

**MONTECITO FIRE PROTECTION DISTRICT
WARRANTS AND CLAIMS DETAIL
February 2014**

| Payee | Description | Amount |
|--------------------------------------|--|-----------|
| <u>Fund 3650 - General</u> | | |
| Accountemps | Temporary accounting support | 7,606.10 |
| Across The Street Productions | T. Edwards: Blue Card Certification Training | 4,000.00 |
| ADP Inc | ADP fees, 2 periods | 491.39 |
| Aflac | Employee paid insurance, Feb. | 1,472.62 |
| AG Ent. Inc | Backflow preventer test, Sta. 1, 2 | 280.00 |
| Allstar Fire Equipment Inc | PPE Clothing: Fire hoods/ratchet suspension | 638.23 |
| Bound Tree Medical | Medical supplies | 924.95 |
| Burtens Fire Inc | Vehicle supplies for E91 | 39.76 |
| Carquest Auto Parts | Vehicle maintenance parts | 364.39 |
| Chaz Sportswear | Repair uniform jacket | 17.28 |
| Community Radio Inc | Gibraltar space rental, quarterly | 825.00 |
| Cox Communications | CAD connectivity & Internet | 2,664.42 |
| Dewitt Pinto Petroleum | Diesel Fuel | 3,180.97 |
| Galbraith, Robert | Training reimbursement: ACLS renewal | 160.50 |
| Hydrex Pest Control | Quarterly pest control maintenance, Sta. 1 | 103.00 |
| Informa Corp | Computer support | 2,100.00 |
| Interstate Batteries of Sierra Madre | Batteries for E93 | 669.33 |
| JDL Mapping | Mapping services | 520.00 |
| Johanna Mangual Ledesma | Interview transcription service | 423.33 |
| Kimball Midwest Corp | Mechanic shop supplies | 65.32 |
| Liebert Cassidy Whitmore | Labor attorney fees, Dec. | 265.00 |
| Marborg Industries | Refuse disposal, Sta. 1 | 358.26 |
| Med Tech Resource | Drug module for Sq91 EMS bag | 59.07 |
| Mesa Tree Company | Brush clearing - Oak Creek Cyn | 925.00 |
| MGB Industrial Supply | Air reel repair, Sta. 2 | 165.52 |
| Mission Uniform Service Inc | Shop towels cleaning service | 351.73 |
| Montecito Association | Annual membership dues | 500.00 |
| Montecito Journal | Ordinance publication | 900.00 |
| Montecito Village Hardware | Sawzall blades and extension cord | 71.24 |
| Montecito Water District | Water service | 409.20 |
| Nestle Pure Life Direct | Bottled water | 180.64 |
| Peyton Scapes | Landscaping services | 500.00 |
| Price Postel & Parma | Legal services, Dec. | 4,690.50 |
| Sansum Clinic | Medical exams | 14,438.50 |
| Satcom Global Inc | Satellite phone charges, 2 months | 298.56 |
| SB County Auditor-Controller | Additional user tax payment | 3.96 |
| Silverado Avionics Inc | Vehicle charger for PT92 radio | 190.25 |
| Sintra Group | Pre-employment background | 915.00 |
| SM Tire | Squad 91 tires | 597.89 |
| Southern California Edison | Electricity service | 1,752.27 |
| Sprint | E92 Sim card for MDC | 37.99 |
| Staples Credit Plan | Office supplies | 185.55 |
| State Compensation Insurance Fund | Worker's comp premium, February | 56,349.75 |

| Payee | Description | Amount |
|---|---|-------------------|
| State Compensation Insurance Fund | Worker's comp premium, March | 56,349.75 |
| Streamline Office Solutions | Office copier usage fee, 4 months | 595.05 |
| The Gas Company | Gas service | 183.55 |
| The UPS Store | Shipping charges | 64.36 |
| The Village Service Station | Gasoline charges | 1,569.67 |
| United Drain | Sink repair, Sta. 1 | 95.00 |
| US Bank Corporate Card | Modular adapter plug | 43.99 |
| US Bank Corporate Card | Business meetings and MERRAG snacks | 160.73 |
| US Bank Corporate Card | Flashlight batteries | 336.93 |
| US Bank Corporate Card | Office supplies | 25.91 |
| US Bank Corporate Card | Gasoline charges | 300.33 |
| US Bank Corporate Card | Training: A. Gil - PEPRA Webinar | 30.00 |
| Venable, John | Gas mileage reimb. - Special District Meeting | 44.80 |
| Ventura County Fire Protection | Training: Rescue Systems 2 for Zeitsoff/Blake | 900.00 |
| Verizon California | Telephone Service | <u>2,458.52</u> |
| | | <u>173,851.06</u> |
| <u>Fund 3653 - Land & Building</u> | | |
| Price Postel & Parma | Station 3 Legal services, Dec. | <u>324.50</u> |
| <u>Fund 3654 - UHR Mello-Roos</u> | | |
| Price Postel & Parma | UHR Mello Roos Legal services, Dec. | <u>1,032.50</u> |

**MONTECITO FIRE PROTECTION DISTRICT
PAYROLL EXPENDITURES
February 2014**

| | | | |
|---|-------------------|----------------|-----------------------------|
| Regular Salaries | \$ 474,846.20 | | |
| Directors Fees | 1,920.00 | | |
| Auxiliary | 654.50 | | |
| FLSA Safety | 5,864.80 | | |
| FLSA Dispatch | 2,842.34 | | |
| Regular Overtime | 31,314.18 | | |
| Chief Officers - Extra Duty | 4,710.00 | | |
| Dispatch Cadre Earnings | 1,917.20 | | |
| Hartford 457 Contribution | 8,600.00 | | |
| 4850 Time - S. Bumanglag | <u>8,859.29</u> | | |
| | | Gross Wages | \$ 541,528.51 |
| District Contributions to Insurance | 102,305.72 | | |
| District Contributions to Medicare & FICA | 6,955.71 | | |
| District Contributions to SUI | 69.36 | | |
| PERS, Employee Contribution paid by District | 46,874.74 | | |
| PERS, Employer Contribution paid by Employee (4.5%) | (23,770.49) | | |
| PERS, District Contribution | 120,081.17 | | |
| Due to AFLAC | <u>(1,482.90)</u> | | |
| | | Total Benefits | <u>251,033.31</u> |
| | | Grand Total | <u><u>\$ 792,561.82</u></u> |

**MONTECITO FIRE PROTECTION DISTRICT
OVERTIME COMPENSATION
FEBRUARY 2014**

| Name | Date Worked | Comp Time Hrs | OT Hrs | Total Amount | Sick Relief | Reimb.- Fire Assignment | Emergency Callback | Class Cover | Paramedic Con. Ed | Flex Day | Extra Staffing | Shift Vacancy | BC Coverage | Dispatch Coverage | Other | Description |
|--------------------|-------------|---------------|------------------|-----------------|---------------|-------------------------|--------------------|---------------|-------------------|--------------|-----------------|------------------|-----------------|-------------------|---------------|----------------------------|
| D. Andreas | 02/01/14 | | 1.00 | 76.70 | 76.70 | | | | | | | | | | | |
| D. Andreas | 02/03/14 | | 2.00 | 153.39 | | | | | | | | | | | 153.39 | HazMat Meeting |
| L. Bass | 02/03/14 | | 2.00 | 120.96 | | | | | | | | | | | 120.96 | HazMat Meeting |
| L. Bass | 02/07/14 | | 24.00 | 1,451.52 | | | | | | | | 1,451.52 | | | | |
| G. Blake | 02/09/14 | | 24.00 | 1,425.60 | | | | | | | | 1,425.60 | | | | |
| A. Broumand | 02/12/14 | | 3.50 | 204.54 | | | | | | | | | | | 204.54 | CERT Training |
| S. Chapman | 01/30/14 | | 14.00 | 736.47 | | | 736.47 | | | | | | | | | |
| S. Chapman | 02/01/14 | | 24.00 | 1,262.52 | | | | | | | | | | | | |
| D. Holthe | 01/30/14 | | 6.50 | 443.14 | | | 443.14 | | | | | | | | | |
| D. Holthe | 02/08/14 | | 24.00 | 1,636.20 | | | | | | | | 1,636.20 | | | | |
| D. Holthe | 02/11/14 | | 2.50 | 170.44 | | | 170.44 | | | | | | | | | |
| E. Klemowicz | 01/29/14 | | 3.50 | 188.90 | | | | | | | | 188.90 | | | | |
| K. Mann | 02/08/14 | | 24.00 | 1,636.20 | | | | | | | | 1,636.20 | | | | |
| R. McCracken | 02/01/14 | 8.00 | 16.00 | 974.88 | 974.88 | | | | | | | | | | | |
| R. McCracken | 02/07/14 | 8.00 | 16.00 | 974.88 | | | | | | | | | | 974.88 | | |
| R. McCracken | 02/11/14 | | 2.50 | 152.33 | | | 152.33 | | | | | | | | | |
| T. Poulos | 02/01/14 | | 24.00 | 1,459.80 | 1,459.80 | | | | | | | | | | | |
| J. Villareal | 02/05/14 | | 4.00 | 292.62 | | | 292.62 | | | | | | | | | |
| J. Villareal | 02/10/14 | | 24.00 | 1,755.72 | | | | | | 1,755.72 | | | | | | |
| R. Walkup | 02/11/14 | | 3.00 | 166.05 | | | 166.05 | | | | | | | | | |
| J. Jenkins | 02/11/14 | | 19.00 | 1,884.42 | | | | | | | | | | 1,884.42 | | |
| L. Muller | 02/05/14 | | 24.00 | 1,053.00 | | | | | | | | | | 1,053.00 | | |
| A. Briner | 02/19/14 | | 24.00 | 1,322.28 | | | | | | | 1,322.28 | | | | | |
| A. Broumand | 02/13/14 | | 3.50 | 204.54 | | | | | | | | | | | 204.54 | CERT Training |
| S. Chapman | 02/11/14 | | 3.00 | 157.82 | | | 157.82 | | | | | | | | | |
| S. Davis | 02/19/14 | | 24.00 | 1,365.84 | | | | | | | | 1,365.84 | | | | |
| K. Hickman | 02/15/14 | | 6.50 | 399.65 | | | | | | | | 399.65 | | | | |
| E. Klemowicz | 02/22/14 | | 9.50 | 512.72 | | | | | | | | 512.72 | | | | |
| B. Koepke | 02/11/14 | | 3.00 | 235.40 | | | | | 235.40 | | | | | | | |
| B. Koepke | 02/19/14 | | 24.00 | 1,883.16 | | | | | | | 1,883.16 | | | | | |
| B. Koepke | 02/21/14 | | 0.50 | 39.23 | | | | | | | | 39.23 | | | | |
| T. Poulos | 02/14/14 | | 24.00 | 1,459.80 | | | | | | | | 1,459.80 | | | | |
| K. Powell | 02/19/14 | | 24.00 | 1,295.28 | | | | | | | 1,295.28 | | | | | |
| E. Skei | 02/14/14 | | 3.50 | 249.90 | | | | | | | | | | | 249.90 | RTF Oversight Committee |
| D. St. Oegger | 02/06/14 | | 4.00 | 254.28 | | | | 254.28 | | | | | | | | |
| D. St. Oegger | 02/19/14 | | 24.00 | 1,525.68 | | | | | | | 1,525.68 | | | | | |
| J. Villareal | 02/05/14 | | 2.00 | 146.31 | | | | | | | | | | | | |
| J. Zeitsoff | 02/19/14 | | 24.00 | 1,229.40 | 146.31 | | | | | | | | | | | |
| J. Jenkins | 02/19/14 | | 2.00 | 198.36 | | | | | | | | | | 198.36 | | |
| L. Muller | 02/19/14 | | 14.00 | 614.25 | | | | | | | | | | 614.25 | | |
| G. Ventura | 02/13/14 | 6.00 | - | - | | | | | | | | | | | | Board Meeting Prep/Minutes |
| T. Edwards | 02/08/14 | | 24.00 | 1,884.00 | | | | | | | | | 1,884.00 | | | |
| T. Edwards | 02/21/14 | | 12.00 | 942.00 | | | | | | | | | 942.00 | | | |
| S. Pfister | 02/19/14 | | 24.00 | 1,884.00 | | | | | | | | | 1,884.00 | | | |
| Grand Total | | | 36,024.18 | 4,363.35 | 12.11% | 0.00% | 1,675.73 | 254.28 | 235.40 | 0.00% | 9,011.52 | 10,115.66 | 4,710.00 | 4,724.91 | 933.33 | |
| % of Total | | | 100.00% | | 12.11% | 0.00% | 4.65% | 0.71% | 0.65% | 0.00% | 25.02% | 28.08% | 13.07% | 13.12% | 2.59% | |

**MONTECITO FIRE PROTECTION DISTRICT
SUMMARY OF OVERTIME EXPENSE BY CATEGORY
FY 2012-13**

| Month Paid | Sick | Fire Assign & Callback | Pre-build Inspection | Class Cover | Paramedic | Flex Day | Extra Staffing | Shift Vacancy | BC Coverage | Dispatch Coverage | Other | Total OT | Monthly % of Total | Cum. % of Total |
|--------------|-------------------|------------------------|----------------------|------------------|-----------------|------------------|------------------|-------------------|------------------|-------------------|------------------|---------------------|--------------------|-----------------|
| JULY | 2,934.00 | 4,381.03 | - | 429.30 | 790.68 | 8,621.64 | 1,865.16 | 37,546.02 | - | 6,284.02 | 2,941.07 | 65,792.92 | 6.1% | 6.1% |
| AUGUST | 12,344.15 | 76,026.26 | 5,674.27 | 3,078.82 | 700.61 | 14,043.84 | 1,070.37 | 50,526.54 | 1,884.00 | 6,776.12 | 2,235.79 | 174,360.77 | 16.1% | 22.2% |
| SEPTEMBER | 9,619.56 | 58,014.16 | - | 5,935.32 | 773.57 | 8,749.08 | - | 58,064.58 | 16,956.00 | 3,791.52 | 5,147.72 | 167,051.51 | 15.4% | 37.6% |
| OCTOBER | 16,776.96 | 4,850.59 | - | 6,517.80 | 113.82 | 9,017.88 | 5,338.47 | 51,423.70 | 1,884.00 | 5,265.05 | 5,884.17 | 107,072.44 | 9.9% | 47.5% |
| NOVEMBER | 13,379.80 | 5,876.93 | - | - | 628.82 | 8,289.60 | 1,218.24 | 54,593.07 | 5,652.00 | 5,481.84 | 598.47 | 95,718.77 | 8.8% | 56.4% |
| DECEMBER | 12,630.64 | 374.96 | - | 4,403.61 | 113.82 | 2,168.82 | - | 16,157.43 | - | 5,182.84 | 4,840.67 | 45,872.79 | 4.2% | 60.6% |
| JANUARY | 21,726.48 | 10,232.81 | 983.28 | - | 229.54 | 8,201.91 | - | 29,201.05 | 1,884.00 | 5,432.76 | 2,571.43 | 80,463.26 | 7.4% | 68.0% |
| FEBRUARY | 21,023.89 | 238.61 | - | 486.60 | 617.03 | - | - | 17,724.02 | 7,536.00 | 2,478.78 | 5,317.86 | 55,422.79 | 5.1% | 73.1% |
| MARCH | 7,806.12 | 1,154.21 | - | 1,148.59 | 605.89 | 1,462.32 | - | 4,574.75 | 5,652.00 | - | 1,274.42 | 23,678.30 | 2.2% | 75.3% |
| APRIL | 10,465.20 | 7,514.47 | - | 3,085.42 | 534.34 | 4,226.40 | 2,707.52 | 13,714.44 | 12,246.00 | 4,035.24 | 3,832.02 | 62,361.05 | 5.8% | 81.1% |
| MAY | 6,058.56 | 34,924.36 | - | 179.29 | 1,766.81 | 6,840.15 | 340.88 | 17,939.55 | 4,710.00 | 9,816.22 | 3,600.35 | 86,176.17 | 8.0% | 89.1% |
| JUNE | 2,804.36 | 68,659.48 | - | - | 1,092.31 | 2,700.72 | 11,628.81 | 20,789.40 | 5,652.00 | 3,296.52 | 1,856.90 | 118,480.50 | 10.9% | 100.0% |
| TOTAL | 137,569.72 | 272,247.87 | 6,657.55 | 25,264.75 | 7,967.24 | 74,322.36 | 24,169.45 | 372,254.55 | 64,056.00 | 57,840.91 | 40,100.87 | 1,082,451.27 | 100.0% | |
| | 12.7% | 25.2% | 0.6% | 2.3% | 0.7% | 6.9% | 2.2% | 34.4% | 5.9% | 5.3% | 3.7% | | | |

Fire Assignment Reimbursements Received:

| Date | Source | Amount |
|-----------------|-------------|------------|
| 1/25-3/4/13 | State of CA | 11,322.87 |
| 9/28/12-1/25/13 | USFS | 223,953.02 |

**MONTECITO FIRE PROTECTION DISTRICT
SUMMARY OF OVERTIME EXPENSE BY CATEGORY
FY 2013-14**

| Month Paid | Sick | Reimb.-Fire Assignment | Emergency Callback | Class Cover | Paramedic | Flex Day | Extra Staffing | Shift Vacancy | BC Coverage | Dispatch Coverage | Other | Total OT | Monthly % of Budget | Cum. % of Budget |
|---------------|------------------|------------------------|--------------------|-----------------|-----------------|------------------|------------------|-------------------|------------------|-------------------|------------------|-------------------|---------------------|------------------|
| JULY | 17,047.80 | 21,550.17 | 1,005.12 | 1,475.64 | 516.83 | 6,730.92 | 13,279.82 | 15,550.45 | 9,420.00 | 3,630.96 | 3,726.19 | 93,933.90 | 11.1% | 11.1% |
| AUGUST | 15,315.23 | 60,900.04 | - | 1,322.28 | 110.79 | 10,935.72 | - | 20,107.22 | - | 861.96 | 824.53 | 110,377.77 | 13.0% | 24.0% |
| SEPTEMBER | 12,665.18 | 94,071.40 | 2,211.15 | 2,691.72 | 429.27 | 2,722.32 | 1,726.31 | 12,127.25 | 1,884.00 | 1,763.10 | 4,918.40 | 137,210.10 | 16.1% | 40.2% |
| OCTOBER | 21,165.09 | - | 1,961.08 | 1,306.28 | 470.86 | 4,835.64 | - | 18,184.57 | 9,420.00 | 1,993.32 | 7,271.41 | 66,608.25 | 7.8% | 48.0% |
| NOVEMBER | 3,594.15 | - | 6,945.40 | 1,586.97 | 350.09 | 1,425.60 | - | 5,882.79 | 4,710.00 | 2,540.88 | 5,462.78 | 32,498.66 | 3.8% | 51.8% |
| DECEMBER | 6,826.38 | 9,239.53 | 1,316.32 | - | - | 1,687.95 | - | 24,260.50 | 12,879.42 | 7,330.14 | 399.42 | 63,939.66 | 7.5% | 59.4% |
| JANUARY | 9,070.66 | - | - | 531.59 | - | 2,919.60 | 16,384.59 | 21,701.93 | 7,536.00 | 7,897.86 | 1,171.76 | 67,213.98 | 7.9% | 67.3% |
| FEBRUARY | 4,363.35 | - | 1,675.73 | 254.28 | 235.40 | - | 9,011.52 | 10,115.66 | 4,710.00 | 4,724.91 | 933.33 | 36,024.18 | 4.2% | 71.5% |
| TOTAL | 90,047.84 | 185,761.14 | 15,114.79 | 9,168.76 | 2,113.24 | 31,257.75 | 40,402.24 | 127,930.37 | 50,559.42 | 30,743.13 | 24,707.82 | 607,806.49 | 71.5% | |
| | 14.8% | 30.6% | 2.5% | 1.5% | 0.3% | 5.1% | 6.6% | 21.0% | 8.3% | 5.1% | 4.1% | 100.0% | | |
| Budget | | | | | | | | | | | | | \$ | 850,000 |

Fire Assignment Reimbursements Received:

| Date | Source | Amount |
|---------------|-------------|------------|
| 9/17-1/7/14 | State of CA | 329,577.99 |
| 9/18-11/18/13 | USFS | 159,837.20 |

**MONTECITO FIRE PROTECTION DISTRICT
FIRE ASSIGNMENTS - BILLING
FY 2013-2014**

| Fire Name, # | Invoice # | Period Covered | Date Billed/ Inv. Rec'd | Agency | Total Due | Date Rec'd | Amt. Rec'd. |
|--------------------------------|--------------|----------------|----------------------------|---------|----------------------|------------|----------------------|
| West Fork Complex, CO-SJF-0285 | 2013-04 | 7/2-7/11/13 | 08/07/13 | USFS | \$ 18,460.49 | 11/14/13 | \$ 18,460.49 |
| Chariot Fire, CA-MVU-014084 | | 7/8-7/11/13 | 09/03/13 | Cal-EMA | 29,226.50 | 12/04/13 | 29,226.50 |
| Falls Fire, CA-CNF-002512 | | 8/6-8/8/13 | 09/09/13 | Cal-EMA | 23,401.17 | 12/03/13 | 23,401.17 |
| Silver Fire, CA-RRU-079781 | | 8/8-8/10/13 | 09/03/13 | Cal-EMA | 29,398.41 | 12/04/13 | 29,398.41 |
| American Fire, CA-TNF-1562 | 2013-06 | 8/12-8/19/13 | 09/12/13 | USFS | 12,499.70 | | - |
| American Fire, CA-TNF-1562 | | 8/15-8/18/13 | 03/10/14 | Cal-EMA | 7,082.56 | | - |
| Shirley Fire, CA-SQF-3228 | | 8/19-8/20/13 | 10/03/13 | Cal-EMA | 14,621.27 | 12/06/13 | 14,621.25 |
| Shirley Complex, CA-SQF-3229 | | 8/20-8/23/13 | 09/09/13 | Cal-EMA | 35,955.94 | 12/09/13 | 35,955.95 |
| Hough Complex, CA-PNF-1324 | 2013-07 Rev. | 8/19-8/28/13 | 10/03/13 | USFS | 37,607.18 | | - |
| Rim Fire, CA-STF-2857 | | 8/23-9/3/13 | | Cal-EMA | 156,698.60 | 01/07/14 | 156,698.60 |
| Pfeiffer Fire, CA-LPF-3810 | 2013-08 | 12/16-12/22/13 | 01/28/13 | USFS | 23,511.23 | | - |
| | | | | | \$ 388,463.05 | | \$ 307,762.37 |

PRICE, POSTEL & PARMA LLP

COUNSELLORS AT LAW
POST OFFICE BOX 99
SANTA BARBARA, CA 93102-0099

(805) 962-0011

TAX ID # 95-1782877

MONTECITO FIRE PROTECTION DISTRICT
595 SAN YSIDRO ROAD
SANTA BARBARA, CA 93108

January 14, 2014
File #: 12611
Invoice #: 114818
Billing Attorney: MSM

ACCOUNT SUMMARY BALANCE

| | |
|----------------------------------|----------------------|
| RE: GENERAL MATTERS | 265.50 |
| Our File Number: 12611-00000 | |
| RE: ORDINANCES | 2,360.00 |
| Our File Number: 12611-00022 | |
| RE: STATION THREE | 324.50 - FUND 3653 |
| Our File Number: 12611-00059 | |
| RE: BOARD MTGS | 2,065.00 |
| Our File Number: 12611-00061 | |
| RE: MELLO ROOS - UPPER HYDE ROAD | 1,032.50 - FUND 3654 |
| Our File Number: 12611-00077 | |

| | |
|------------------------------|---------------------------|
| Current Total Charges | 6,047.50 |
| | - 324.50 |
| * * * * * | - 1,032.50 |
| | <u>4,690.50</u> FUND 3650 |

SUMMARY OF CURRENT CHARGES

| | | |
|----------------------------|-----------------|-------------------|
| Current Fees | 6,047.50 | |
| Total Current Fees & Costs | <u>6,047.50</u> | |
| Total Current Due | | \$6,047.50 |

SUMMARY OF PAST DUE BALANCES

| | |
|-----------------------|---------------|
| Total Past Due | \$0.00 |
|-----------------------|---------------|

| | |
|-----------------------------------|-------------------|
| TOTAL CURRENT AND PAST DUE | \$6,047.50 |
|-----------------------------------|-------------------|

BALANCE IS DUE UPON RECEIPT.

THE FIRM'S HOURLY RATES ARE REVIEWED ANNUALLY AND
MAY CHANGE EFFECTIVE JANUARY 1ST UNLESS OTHERWISE AGREED.

gp 1/24/14

Agenda

Item #4

MINUTES FOR THE REGULAR MEETING OF THE BOARD OF DIRECTORS
MONTECITO FIRE PROTECTION DISTRICT

Held at Fire District Headquarters, 595 San Ysidro Road, February 18, 2014 at 2:00 p.m.

The meeting was called to order by Director Venable at 2:00 p.m.

Present: Director Venable, Director Powell, Director Sinser and Director Jensen. Director Keller was absent. Chief Hickman and District Counsel, M. Manion, were also present.

- 1. Public comment: Any person may address the Board at this time on any non-agenda matter that is within the subject matter jurisdiction of the Montecito Fire Protection District. (30 minutes total time is allotted for this discussion.)**

No public comment.

The Board took no action.

- 2. Review current status of Upper Hyde Road Community Facilities District:**

- a. Report from Director Powell regarding meetings with Upper Hyde Road residents.**

The Upper Hyde Road homeowners are continuing to work towards establishing a joint account to prepare the construction documents and permit to build the proposed driveway using private financing. They expect to have additional information within two months.

Public Comment:

Roger Collis explained that their current plan is to obtain all funds necessary and establishing an escrow account for road surveying, bidding process, drafting of the construction documents and legal fees to create a payment agreement between the property owners. The goal is to start construction by June 1st, 2014.

- b. Provide direction on how to proceed with Tea Fire Rebuilds and Upper Hyde Road Community Facilities District.**

The Board took no action.

- 3. Approve first reading by title only of Ordinance No. 2014-01 adopting the Fire Protection Plan for the Montecito Fire Protection District and repealing Ordinance No. 2010-02.**

Chief Gregson presented the revised version of the District's "Fire Hazard Severity Zones" map and how it was modified from the previous meeting. He also reported that he has invited the State Fire Marshal to come to the District to assess their severity zone maps.

Public comment:

Sandie Owens advised that her State Farm Insurance agent informed her that all of Montecito is considered a high risk area regardless of the maps and that they are not writing new policies for homes in the District. She added that conditions by which they might consider insuring a home for them if the moved to another location in the area included having 25 foot roadways, 300 foot brush clearance around the property, and that the home must be within 5 minutes of a fire station.

Sylvia Easton indicated that fire danger could easily exist down below Highway 192 because of all the trees and brush leading down to that area. She also commented on the importance of the chipping projects.

A motion was made by Director Jensen, seconded by Director Sinsler, approving the first reading by title only of Ordinance 2014-01 of the Governing Board of the Montecito Fire Protection District Adopting the Fire Protection Plan of the Montecito Fire Protection District and Repealing Ordinance Number 2010-02.

The motion was approved by the following roll call vote:

Ayes: G. Sinsler, J.A. Powell, R.J. Jensen, J. Venable
Noes: None
Abstain: None
Absent: S. Keller

4. Update on Status of Fire Station 3 Environmental Impact Report.

Director Sinsler removed himself from the Dais.

Mr. Manion indicated that he and Chief Hickman met with the EIR consultants from AMEC to review the proposed timeline for issuing the new EIR. The draft EIR will be posted for 45 days to allow for public comment. A final draft EIR will be likely prepared for Board review at the August regular Board meeting.

The Board took no action.

Director Sinsler returned to the Dais.

5. Approval of District warrants and claims.

After explanations of State Compensation Insurance Fund dividends, attorney fees, and Shepard Mesa work, the January warrants and claims were unanimously approved on a motion by Director Powell, seconded by Director Sinsler.

Public comment:

Warner Owens asked if a Director can go directly to the Accountant prior to a Board meeting to clarify questions. The Chief advised that he prefers requests for information be directed at him.

6. Approval of Resolution 2014-04 regarding changing the date of regular Board Meetings.

Chief Hickman explained that the request to move regular Board meetings was to allow the Finance Committee sufficient time to review the financial reports prior to the regular Board meeting.

On a motion made by Director Sinsler, seconded by Director Powell, the Board approved Resolution 2014-04 of the Board of Directors of the Montecito Fire Protection District in the Matter of Setting the Time and Place Holding Regular Board Meetings was approved by the following roll call vote:

Ayes: G. Sinsler, J.A. Powell, J. Venable, R.J. Jensen

Noes: None
Abstain: None
Absent: S. Keller

7. Report on current drought situation and how it may affect fire suppression and District operations.

Chief Hickman reported that the District is reducing water use by 30%, as requested by the Water District. Operationally, hose training and hydrant testing have been cancelled.

Chief Hickman explained that he is also exploring options for fire suppression, including the purchase of a water tender or placement of temporary water tanks in high risk areas.

The Board took no action.

8. Report from the Finance Committee (copy of Agenda for Finance Committee Meeting attached).

Director Sinser reported that the Committee reviewed the monthly financial reports and the recent form sent to PARS to change the investment strategy.

a. Consider recommendation to approve purchase of Chief's vehicle.

Chief Hickman discussed the need for a new vehicle based on mileage and service years for the vehicle as well as the methods used to dispose of the old vehicle.

The Board took recess at 2:58 p.m. and reconvened at 3:08 p.m.

On a motion made by Director Sinser, seconded by Director Venable, the Board unanimously approved the purchase of the Chief's vehicle.

9. Report from the Community Outreach Committee (copy of Agenda for Community Outreach Committee Meeting attached).

a. Consider recommendation for use of NIXLE and classification of messages.

Director Sinser described a water break that occurred near his residence and stated that the Communication Committee recommends that the District communicate events such as water line breaks and power outages utilizing the District's a NIXLE service and categorized as "Advisory" notification.

Director Jensen expressed concern that this is an issue outside of the District's mission.

Chief Hickman explained that NIXLE can target areas in the District for notifications, but it is not as specific as a reverse-911.. He expressed concern that by frequently notifying our residents with non –emergency information, they may unsubscribe from NIXLE, thus defeating the purpose of being able to notify residents in emergency situations.

Public comment:

Sylvia Easton expressed that she feels NIXLE is a great service that should not be overused.

A motion was made by Director Sinser to utilize NIXLE Advisory notifications to notify the community of water line breaks, power outages, and other similar situations. The motion died by lack of a second.

10. Approval of Minutes of January 21, 2014 Regular Meeting.

After making several corrections, the Board unanimously approved the amended minutes of January 21, 2014 Regular Meeting on a motion made by Director Powell, seconded by Director Venable.

11. Fire Chief's report.

Chief Hickman reported on the February 11th brush fire in Carpinteria's Toro Canyon area; a freeway median fire near Coast Village circle; and a predicted wind event expected on February 19th.

The Board took no action.

12. Board of Director's report.

Director Venable reported on his attendance at the LAFCO meeting in which Jeff Moorhouse was nominated as the Special District Member.

Director Powell expressed a concern about how the Committees are currently being handled. He asked that Committee members improve reporting and clearly articulate their recommendations that require Board action.

13. Suggestions from Directors for items other than regular agenda items to be included for the March 2014 Regular Board meeting.

There were no suggestions.

The meeting was adjourned at 3:43 p.m.

John Venable

John Abraham Powell

Agenda

Item #5

MINUTES FOR THE REGULAR MEETING OF THE BOARD OF DIRECTORS
MONTECITO FIRE PROTECTION DISTRICT

Held at Fire District Headquarters, 595 San Ysidro Road, February 25, 2014.

The meeting was called to order by Director Venable at 8:00 a.m.

Present: Director Venable, Director Powell, Director Sinser and Director Jensen. Director Keller was absent. Chief Hickman.

- 1. Public comment: Any person may address the Board at this time on any non-agenda matter that is within the subject matter jurisdiction of the Montecito Fire Protection District. (30 minutes total time is allotted for this discussion.)**

Kaj Hoffman stated that he was thankful for the brush chipping program and requested more advance notice to allow residents to plan for the chipping.

- 2. Award contract responsible low bidder for the District's Defensible Space Chipping Projects.**

Chief Hickman reviewed the two bids that were submitted and proposed that the Board approve entering into a contract with Branch Out Tree Care Service.

After a discussion about the differences between the two bids, the Board authorized the Fire Chief to enter into an agreement with Branch Out Tree Care Service for the District's Defensible Space Chipping Projects on a motion by Director Powell, seconded by Director Jensen. Directors Venable, Powell and Jensen voted in favor of the motion; Director Sinser voted against the motion.

- 3. Fire Chief's Report.**

Fire Chief reported that the next Board meeting will be on March 24 at 2 pm; request for his participation at the MWD Water Conservation Workshop; and upcoming predicted rain events.

The meeting was adjourned at 8:30 a.m.

Agenda

Item #6

**FEBRUARY 2014
CALLS BY INCIDENT TYPE
TOAL INCIDENTS: 88**

| | |
|-------------------|-------------------|
| FIRE: 3 | EMS: 48 |
| HAZ. CONDITION: 4 | PUBLIC SERVICE: 8 |
| GOOD INTENT: 18 | FALSE ALARM: 5 |
| SEVERE WEATHER: 2 | |

